

# Electronic Control Systems

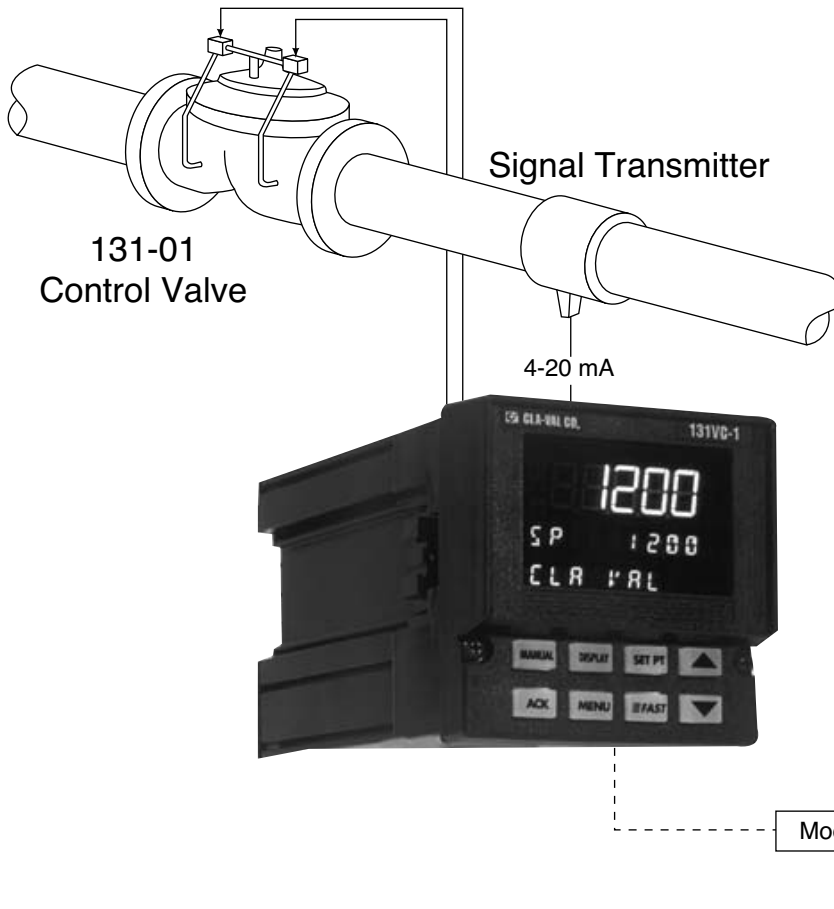

- Electronic Control of Hydraulic Cla-Val Valves
- Programmable Monitoring and Control of Flow, Pressure, Delta P, Level or Valve Position
- Accurate Control of Valve Speed and Response
- Remote Set-Point Control
- Security System - Prevents Unauthorized Changes
- Control Backup Systems in the Event of an Emergency

The Cla-Val 131VC-1 Electronic Control System is designed to achieve unprecedented valve control accuracy and stability. Ideal for remote valve control, the 131VC-1 Electronic Control System provides the interface between SCADA system computers and hydraulic control valves sites.

## Electronic Control of Hydraulic Valves

The 131VC-1 Electronic Control System is designed to work in conjunction with Cla-Val 131 Series hydraulic control valves—a combination that takes advantage of the simplicity of hydraulic valve operation and the control possibilities available with electronics.

The 131VC-1 Electronic Control System receives transmitted signals and activates dual solenoid pilots on the hydraulic control valve. These pilots direct hydraulic pressure within the system to position and regulate the valve. By continuously comparing system conditions to the programmed set-point, the system is automatically maintained at the desired value.

Additional important control features, unique to this type of valve control, are offered as standard. They are designed for user friendly operation and system safety and are addressed in this brochure.

## Key Advantages

- Proven reliable hydraulic control valve
- Low electric power requirement
- Solid state electronic components
- No motors, bearings, bushings or packings to wear out or leak

*We Not Only Sell Valves—  
We Provide Solutions*



## How it Works

### 1. Set-Point Command

Set-point command is received from a remote location or entered via the keypad into the Electronic Valve Controller.

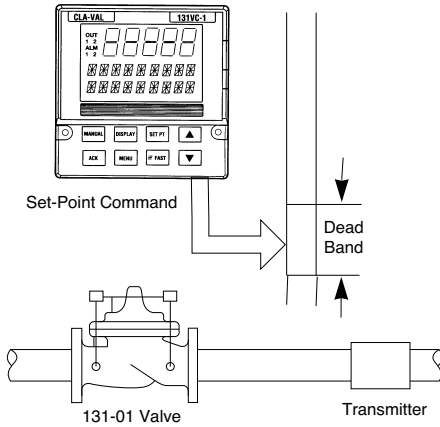

### 2. Feedback and Comparison

The Electronic Valve Controller compares the feedback signal from the transmitter to the set-point. If the deviation exceeds the deadband, the valve control system is activated.

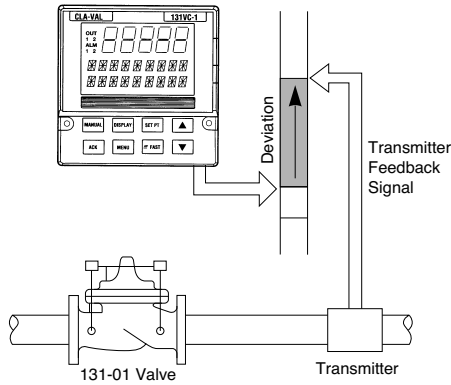

### 3. Valve Actuation

The Electronic Valve Controller actuates the solenoid controls, causing the valve to modulate as needed to regain the set-point condition.

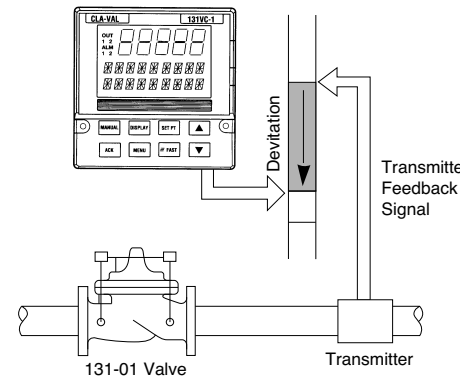

## Keypad & Display

### Display

The 131VC-1 has been engineered to be the industry's most user friendly controller. With three digital displays areas (two offering up to 9 characters of true alphanumeric), the 131VC-1 effectively eliminates cryptic messages, sub-routines and loops that could confuse even the most experienced operator. The bright, crisp display is vacuum fluorescent, and offers much better readability than any other display technology. Additional operator-friendly features include: custom programmable alarm messages, illuminated keys, and an easy-to-use menu system.

**Status Indicators** - Four status indicators show the controller's operating status at all times:

**Manual Key Light:** For manual control.

**Set-point Key Light:** For indication of remote control.

**Output Indicator:** "OUT" and indicator lights illuminate when either output 1 or 2 are on.

**Alarm Indicator:** "ALM" and indicator lights illuminate when either output 1 or 2 are on.

**Keys Pads:** All menu entry, configuration, tuning and set-point controls is entered through rugged backlit rubber keys. A simple menu system prompts the operator, step by step, through all procedures. Security system prevents unauthorized changes to all values.



## Features

**Alarm** - Programmed to signal when system conditions exceed a desired value or in the event of a system component failure. It can be configured to be latching or non-latching, normally open or normally closed contact with deadbands.

### Absolute

Activates when the process variable exceeds alarm set-point. It can be either high and/or low acting.

**Deviation Alarm** - Shifts as the set-point is changed. It can be symmetrical or asymmetrical.

**Fault Alarm** - Activates when the process variable is lost.

### Alarm

**Set-Point Rate of Change** - Prevents accidental or sudden changes in the programmed set-point. It is also invaluable when used on high differential or surge sensitive applications where valve speed of operation must be tightly controlled.

**Process Variable Backup** - Can automatically recognize secondary process variable or can be programmed to open or close valve or can default to backup pilot system using alarm function.

**DC Power Supply** - Provides source of power for signal transmitter.

**Retransmission** - Transmit process variable or set-point values.

**Offsets** - Adjusts the process variable and remote set point settings if respective signals do not match.

**Filter** - Stabilizes process variable signal when required.

**Security System** - Prevents unauthorized changes.

**Input Linearization** - For flow measurement across orifices, venturies, etc.

**Serial Communications** - RS485 or RS232. (optional)

**Digital Inputs** - Selects specific set-points. (optional)

**NEMA 4X Enclosure** (optional)

## Input Signals

The 131VC-1 Electronic Control System is designed to accept industry standard 4-20 mA full scale signals for pressure, flow or level control from customer supplied transmitter(s).

**Flow Measurement** using a differential signal requires activating the square root extractor to obtain direct flow readout.

**Modulating Level Control** requires the use of an optional X117 Valve Position Transmitter in addition to a level transmitter.

**Valve Position Control** requires an optional X117 Valve Position Transmitter installed on the valve.

Other configurations are available on a special order basis, consult the factory for details.

## Specifications

### Control Input:

4-20 mA full scale (others optional)

### Control Parameters

**Proportional Bands:** 1 to 999%, settable in 0.1% increments independently for opening and closing

**Deadbands:** achievable up to 15% of input range

**Cycle Time:** 1 to 120 seconds in 1 sec. increments.

### Environmental Parameters

**Temperature:** 0°C to 50°C (32°F to 122°F)

**Humidity:** 10 to 90%, non-condensing

### Power Consumption

15 watts Max. at 120 VA, 50/60 Hz

### Voltage and Frequency

Universal power supply: 90 to 250 VAC, 48 to 62 Hz.  
24 to 30 volts AC or DC, +/- 5%.

### Noise Immunity

**Common mode rejection (process input):** >120 db.

**Normal mode rejection (process input):** >80 db.

AC line is double filtered and transient protected.

Snubbers are provided for each relay output.

### Construction

**Case:** extruded, non-perforated black anodized aluminum with ABS plastic sleeve.

**Bezel:** Black plastic ABS.

**Chassis assembly:** plug-in type.

**Keys:** Silicone rubber with diffusion printed graphics.

**NEMA rating:** front panel conforms to NEMA 4X when instrument is properly installed.

### Agency Approvals



LR 84603



LISTED

Process Control Equipment  
4N66

### Memory Retention

Lithium battery maintains all programming for approximately ten years.

### Security

There are two levels of access: restricted and full. A configurable code is used to enter the full access level. Functions not available in the restricted level are configurable.





# How To Order

**131VC -1** 3 3           0 C V

**Output 1: Control**

- Mechanical Relay (5 amp) ..... **1**
- Analog (milliamp) ..... **2**
- Solid State Relay (triac) (1 amp) ..... **3**

**Output 2: Control, Alarm, or Retransmission**

- Mechanical Relay (5 amp) ..... **1**
- Analog (milliamp) ..... **2**
- Solid State Relay (triac) (1 amp) ..... **3**

**Output 3: Control, Alarm, Retransmission, or Loop Power**

- Mechanical Relay (5 amp) ..... **1**
- Analog (milliamp) ..... **2**
- Solid State Relay (triac) (1 amp) ..... **3**
- Loop Power ..... **5**

**Output 4: Alarm, Retransmission, or Loop Power**

- Mechanical Relay (0.5 amp, 24 V) ..... **1**
- Analog (milliamp) ..... **2**
- Solid State Relay (triac) (0.5 amp, 24 V) ..... **3**
- Loop Power ..... **5**

**Options**

*Enter "0" if not desired*

- 24 VAC/24 VDC Operation ..... **F**
- Remote Setpoint ..... **B**
- Set of Five Digital Inputs ..... **D**
- CE Certification ..... **H**
- Five Digital Inputs and CE Certification ..... **J**

**Order Code**

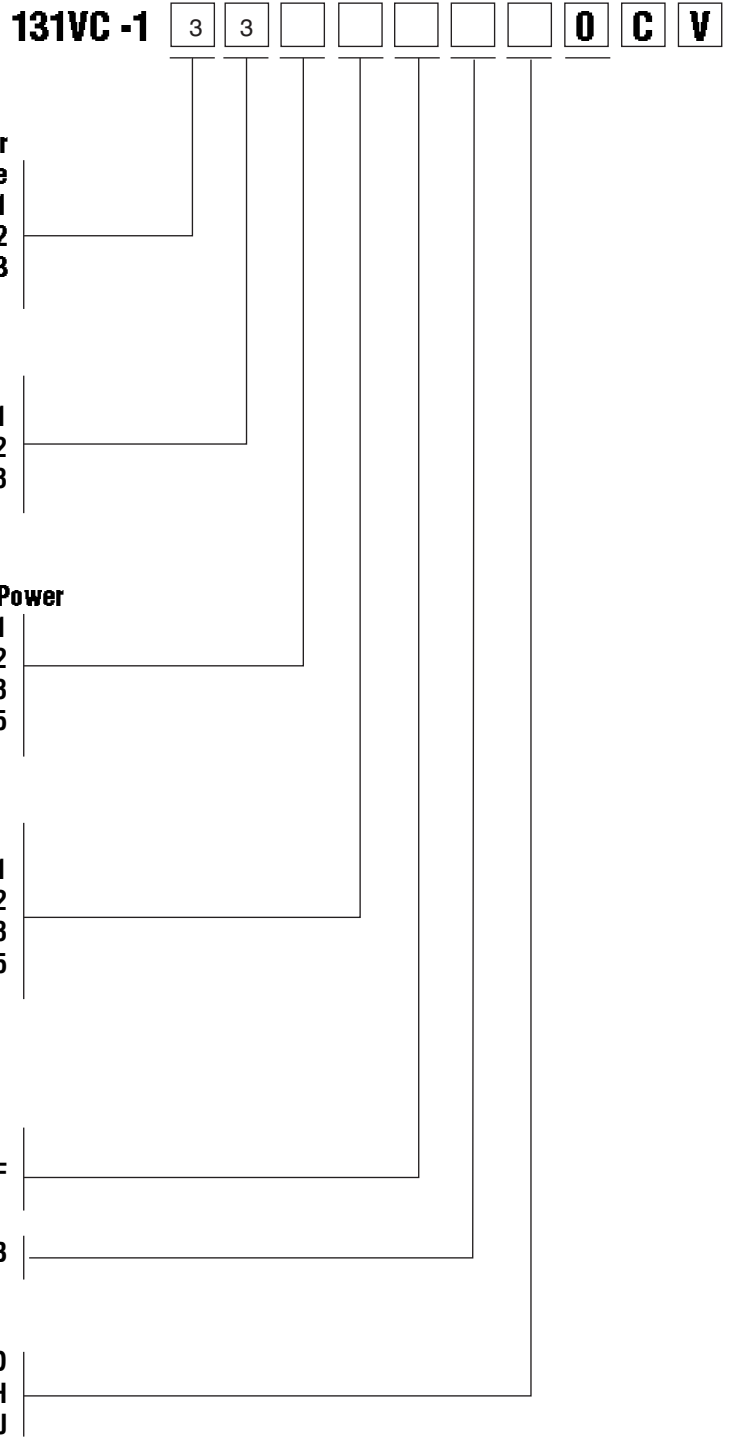

## Programmable Control Features

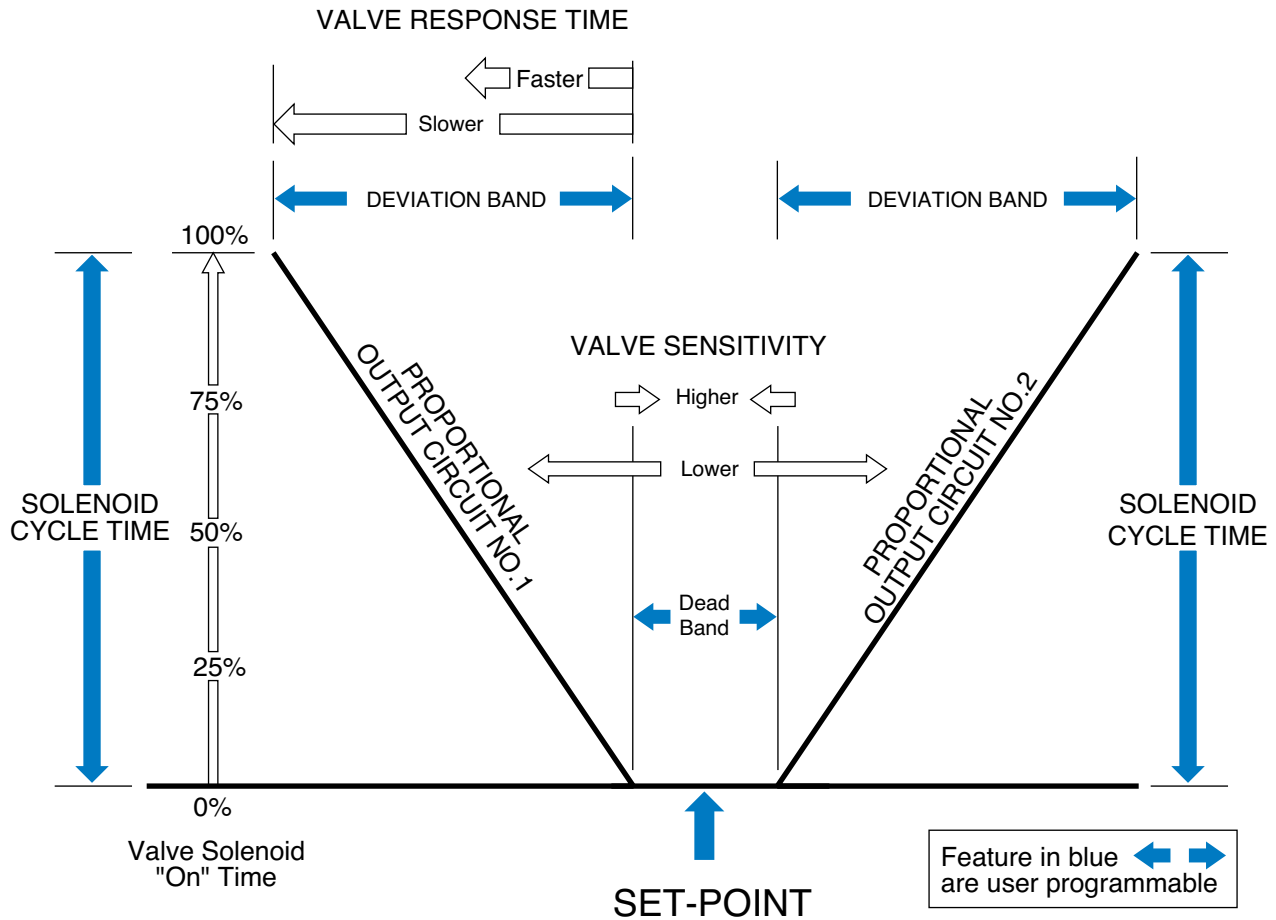

### Full Programmable Control of Valve Sensitivity and Valve Response

Designed with duplex output circuits (one to control the valve opening solenoid and one to control the valve closing solenoid). The 131VC-1 Electronic Control System can be programmed to maintain precise control of any process. Each output circuit has an independently programmable proportional band and solenoid cycle time. By adjusting these control algorithms in combination, the response time can be varied over a wide range.

#### Proportional Band

The proportional band can be programmed from 1 to 999 percent of transmitter scale. Programming a narrow deviation band will result in faster valve response, whereas a wider band will result in slower response.

#### Proportional Response Time

The response time of the valve is proportional to how far the process variable is from the set-point. If there is only a small deviation, the solenoid "on-time" will be short and the valve will move slowly. For large deviations, the "on-time" will be longer and the valve speed will be faster.

### Solenoid Cycle Time

The opening and closing solenoid pilots operate in "on-off" cycles. The cycle time is programmable to allow the valve to make a smooth transition to the set-point and avoid overshooting.

#### Dual Output Circuits

The two output circuits can be programmed independently to respond at different rates. For example: fast response above the set-point; slow response below the set-point.

#### Set-Point Rate of Change

The controller has a ramping function that will further control valve speed of operation. This feature is especially useful in applications where valve speed is critical and pipeline surges are possible. When turned on, the set-point rate of change feature is operational under the following conditions:

- On power up, the set-point will ramp from the process variable value to the set-point value at a specified rate.

- On a transfer from manual to automatic control, the set-point will ramp from the process variable to the set-point value at a specified rate.

- On any set-point change, the set-point will ramp from the current set-point to the new target set-point.



## Applications

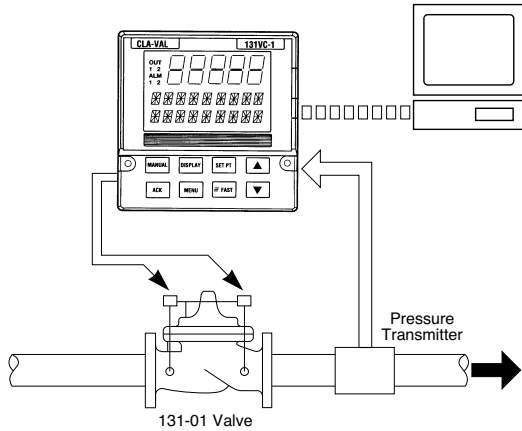

### Pressure Control

Downstream pressure control is easily accomplished. The pressure transmitter range should be selected to provide the desired accuracy of pressure control. The set-point of the controller can be changed by the remote command signal or by manual adjustment at the controller panel. For pressure sustaining control, the transmitter is located upstream of the valve and the solenoid outputs are reversed.

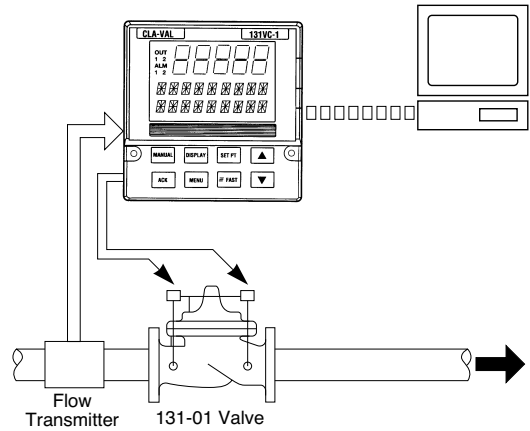

### Flow Control

Flow control uses a flow transmitter in the configuration shown. The flow transmitter range should be selected to provide the desired accuracy of flow control. If desired, the transmitter may be located downstream of the valve, however, it should be a minimum of five to nine diameters downstream of the valve.

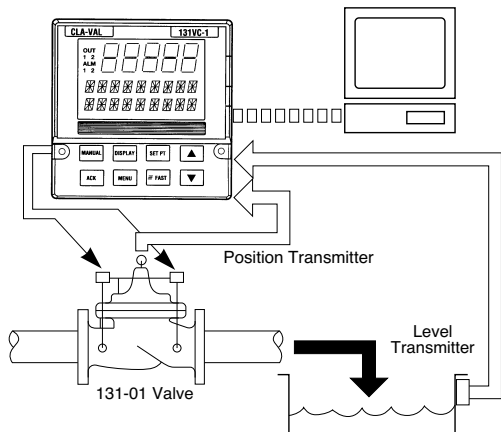

### Modulating Level Control

For modulating level control, the controller accepts the signal from the tank level transmitter as the remote set-point. This signal is then compared with the signal generated by an optional X117 Valve Position Transmitter to adjust the valve proportionally to the range of the level transmitter.

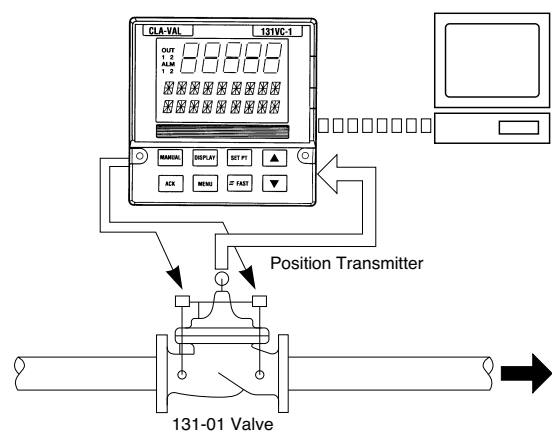

### Position Control

For applications requiring control of valve position, use the optional Cla-Val X117 Valve Position Transmitter. This provides the feedback signal to the controller. A computer or programmable controller (PLC) may receive inputs from other sensors and output a position command signal for use in complex control applications.

## Power Failure Options

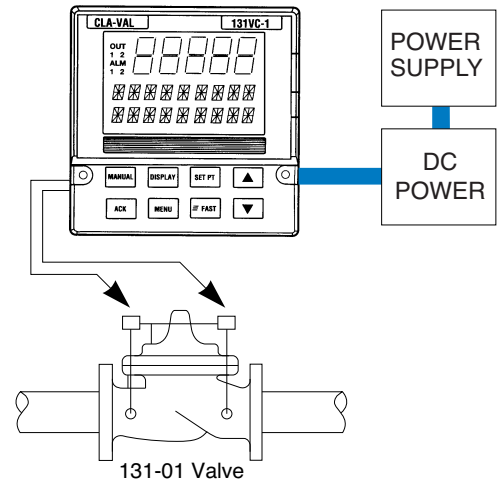
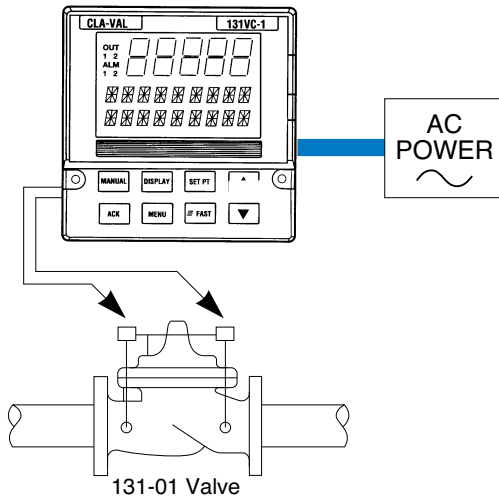

### Maintain Valve Position

When there is a power failure, using the standard Model 131-01 Control Valve, the pilot control solenoids lock in the closed position and hold the main valve in the last control position.

### Direct Voltage Electronic Control

Customer supplied battery power, with a continuous charging system, operates the valve solenoids and controller in the event of power failure.

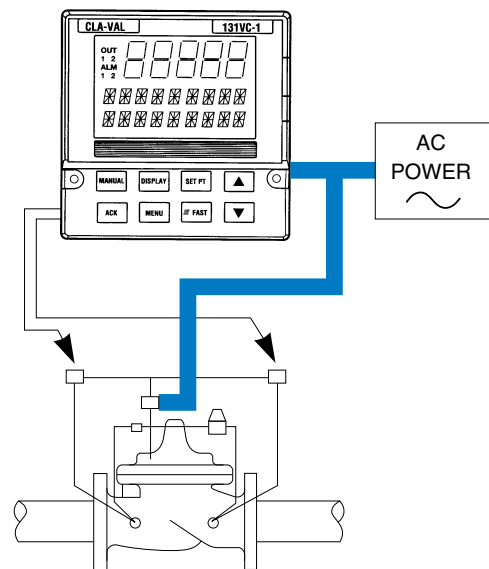
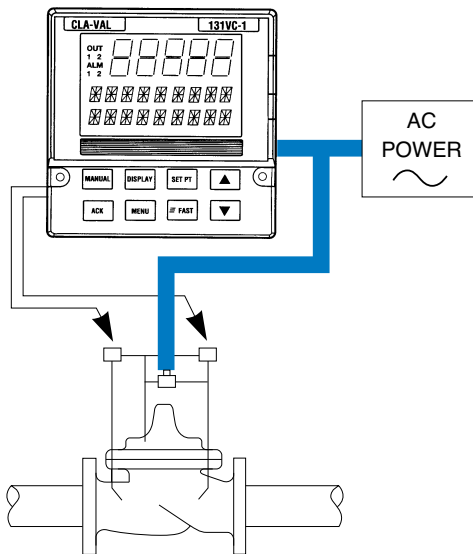

### Open or Close Valve

Adds a third solenoid control to the pilot system which either opens or closes the main valve on power failure.

### Hydraulic Backup

A second hydraulic pilot system is arranged in parallel with the electronic system. On power failure, a third solenoid switches the control from electronic to the backup hydraulic system. The hydraulic system will then modulate the valve to maintain pre-set system conditions. Virtually any hydraulic system can be used.

### Transmitter Signal Failure

The 131VC-1 Electronic Control System contains several indispensable sub-routines that protect the system if there is a transmitter signal failure. The controller has, as standard, terminals for a second transmitter and can be configured to automatically default to that transmitter. The controller can also be configured to cause the valve to remain in last control position, to open or close at an electronically controlled rate, or alarm to an auxiliary hydraulic pilot system.

### Remote Communications Failure

The 131VC-1 Electronic Control System is the final link in the communications system at the valve site. In the event of a failure, the controller will continue to function, maintaining the valve at the last set-point command or a pre-programmed set-point. It can also have a new set-point entered on the key pad by the Operator.

---

## Installation

The electrical power used to energize the solenoid pilot system on the valve is routed through the 131VC-1 Electronic Control System. Because of practical limitations on wire size and distance, we recommend locating the controller near the valve itself.

Transmitter signals of 4-20 mA can travel great distances without difficulty, therefore, the controller does not need to be near the signal transmitter. For outdoor and high humidity indoor applications, we recommend installation in water-tight NEMA 4 enclosures.

---

## Retrofitting CLA-VAL Control Valves

Existing hydraulically operated Cla-Val control valves can easily be converted to operate with the 131VC-1 Electronic Control System. The valve is modified by simply adding the Series 131 Solenoid Pilot System. The Series 131 Pilot System can be installed in parallel with the existing hydraulic pilot control for backup control in case of electrical power failure. In this case, the hydraulic pilot system must be isolated from the valve by a third solenoid valve (see Power Failure Options above).

When the existing Cla-Val control valve performs a combination of control functions (such as pressure reducing and pressure sustaining), the 131VC-1 Electronic Control System will control the primary function of the valve. The other secondary functions will continue to be controlled by the hydraulic pilot controls. Consult Factory for details.

---

## Purchase Specifications

The Electronic Control System shall provide the interface between a remote computer system and the control valve. The controlled parameter signal shall be accepted through a 4-20 mA feedback signal. Local manual set-point control and full manual control of control valve solenoids is to be provided on the controller panel for local control.

Upon receiving the set-point command signal from the remote computer system, the controller will signal the valve to move and maintain the valve at the desired set-point. A vacuum fluorescent display of current status and set-point value in scalable engineering units shall be supplied.

The controller shall compare set-point and feedback values and adjust the valve accordingly to achieve the set-point. When the feedback signal deviates from the set-point value, the appropriate opening or closing solenoid on the control valve shall activate. As the feedback signal approaches the set-point, the solenoid output will pulse on and off to gradually return the measurement to set-point. One solid-state relay energizes for measurements condition below the set-point, while the other energizes for measurement, greater than set-point. These outputs shall be wired directly to or through intermediate relays to the opening and closing solenoids on the control valve. Solenoid output indicator lights shall illuminate when either the open or closed solenoid is activated.

The total cycle time between each pulse shall be programmable between 1 and 120 seconds. The duration of each pulse shall be directly proportional to the deviation from set-point outside of an adjustable deadband. The time proportioned outputs shall be independently adjustable for conditions above and below the set-point to properly tune valve response. The time proportional output band width shall be independently programmable between 1 and 999 percent of full scale. When the feedback signal returns within the deadband zone, the valve will maintain position. Provision shall be made to open/close/maintain position in the event of a loss of the feedback signal.

The operator interface shall consist of two rows of alphanumeric characters to display numeric values and units. Color coded alarm, status and mode indicators shall inform the operator of operating conditions. Security key codes shall protect against undesired changes to the controller. All programming shall be menu driven.

The controller shall be all solid-state construction with the internal chassis capable of being removed for inspection and adjustment. All program memory, including set-points and tuning parameters, shall be protected by an internal lithium battery rated for 10 year life.

Remote communications shall be accepted through a 4-20 mA DC analog set-point signal. When remote operation is selected, the controller shall monitor the remote set-point signal. When local control is selected, the set-point shall be changed at the controller keypad.

When optional remote digital communications are provided, the controller shall be capable of direct linkage to a computer or other instrumentation which has RS-232 or RS-485 communications. The Electronic Control System shall be the Cla-Val Model 131VC-1 as manufactured by Cla-Val, Newport Beach, CA.



E-131VC-1 (R-7/2011)

### CLA-VAL

PO Box 1325 Newport Beach CA 92659-0325  
Phone: 949-722-4800 • Fax: 949-548-5441

#### CLA-VAL CANADA

4687 Christie Drive  
Beamsville, Ontario  
Canada L0R 1B4  
Phone: 905-563-4963  
Fax: 905-563-4040

#### CLA-VAL EUROPE

Chemin des Mesanges 1  
CH-1032 Romanel/  
Lausanne, Switzerland  
Phone: 41-21-643-15-55  
Fax: 41-21-643-15-50

©COPYRIGHT CLA-VAL 2011 Printed in USA  
Specifications subject to change without notice.

[www.cla-val.com](http://www.cla-val.com)

**Represented By:**