



—MODEL—

100-20

600 Series Hytrol Valve



- **Reduced Cavitation Design**
- **Drip-Tight, Positive Seating Action**
- **Service Without Removal From Line**
- **Globe or Angle Pattern**
- **Every Valve Factory Tested**

The Cla-Val Model 100-20 Hytrol Valve is a hydraulically operated, diaphragm actuated, globe or angle pattern valve. It consists of three major components: body, diaphragm assembly and cover. The diaphragm assembly is the only moving part.

The diaphragm assembly is guided top and bottom by a precision machined stem which utilizes a non-wicking diaphragm of nylon fabric bonded with synthetic rubber. A resilient synthetic rubber disc, retained on three and one-half sides by a disc retainer, forms a drip-tight seal with the renewable seat when pressure is applied above the diaphragm.

The reduced cavitation characteristics of the 100-20 Hytrol Valve is the basis for the Cla-Val 600 Series. The rugged simplicity of design and packless construction assure a long life of dependable, trouble-free operation. It's smooth flow passages and fully guided disc and diaphragm assembly assure optimum control when used in piping systems requiring remote control, pressure regulation, solenoid operation, rate of flow control or check valve operation.

Available in various materials and in a wide range of sizes, its applications are unlimited.

Principle of Operation

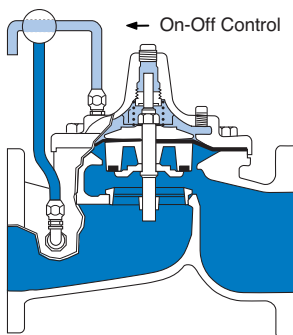

Full Open Operation

When pressure in the cover chamber is relieved to a zone of lower pressure, the line pressure at the valve inlet opens the valve, allowing full flow.

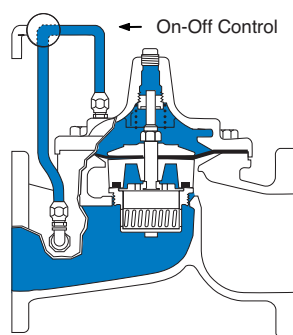

Tight Closing Operation

When pressure from the valve inlet is applied to the cover chamber, the valve closes drip-tight.

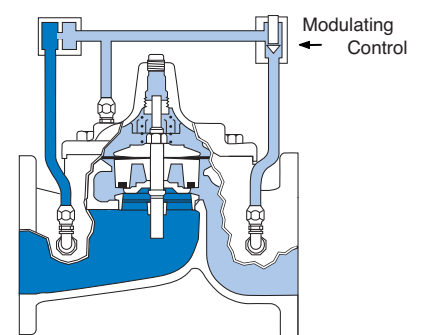

Modulating Action

The valve holds any intermediate position when operating pressure is equal above and below the diaphragm. Using a Cla-Val "Modulating" Control will allow the valve to automatically compensate for line pressure changes.

Specifications

Model 100-20

Available Sizes

Pattern	Flanged
Globe	3", 4", 6", 8", 10", 12", 14", 16", 18", 20", 24", 30", 36, 42", 48"
Angle	4", 6", 8", 10", 12", 14", 16", 18", 20", 24"

Pressure Ratings (Recommended Maximum Pressure - psi)

Valve Body & Cover		Pressure Class		
		Flanged		
Grade	Material	ANSI Standards*	150 Class	300 Class
ASTM A536	Ductile Iron	B16.42	250	400
ASTM A216-WCB	Cast Steel	B16.5	285	400
UNS 87850	Bronze	B16.24	225	400

Note: * ANSI standards are for flange dimensions only.
Flanged valves are available faced but not drilled.

Valves for higher pressure are available; consult factory for details

Materials

Component	Standard Material Combinations		
Body & Cover	Ductile Iron	Cast Steel	Bronze
Available Sizes	3" - 48"	3" - 16"	3" - 16"
Disc Retainer & Diaphragm Washer	Cast Iron	Cast Steel	Bronze
Trim: Disc Guide, Seat & Cover Bearing	Bronze is Standard Stainless Steel is optional		
Disc	Buna-N® Rubber		
Diaphragm	Nylon Reinforced Buna-N® Rubber		
Stem, Nut & Spring	Stainless Steel		
For material options not listed consult factory. Cla-Val manufactures valves in more than 50 different alloys.			

Options

Viton® Rubber Parts - suffix KB

Optional diaphragm, disc and o-ring fabricated with Viton® synthetic rubber. Viton® is well suited for use with mineral acids, salt solutions, chlorinated hydrocarbons, and petroleum oils; and is primarily used in high temperature applications up to 120° C. Do not use with epoxy coatings above 80° C.

Epoxy Coating - suffix KC

The NSF/ANSI 61 fusion bonded epoxy coating option is for use with cast iron, ductile iron or steel valves. This coating is resistant to various water conditions, certain acids, chemicals, solvents and alkalies. epoxy coatings are applied in accordance with AWWA coating specifications C116-03.

Do not use with temperatures above 80° C.

Dura-Kleen® Stem - suffix KD

This stem is designed for applications where water supplies containing dissolved minerals create deposits that build-up on a standard stem and hamper valve operation. A patented, self-cleaning design on the stem allows all valve sizes to operate freely in the harshest conditions.

Delrin® Sleeved Stem - suffix KG

The Delrin® sleeved stem is designed for applications where water supplies contain dissolved minerals which can form deposits that build up on the valve stem and hamper valve operation. Scale build-up will not adhere to the Delrin® sleeve stem. Delrin® sleeved stems are not recommended for valves in continuous operation where differential pressures are in excess of 80 psi (50 mm and larger Hytrol valves).

Operating Temp. Range

Fluids
-40° to 180° F

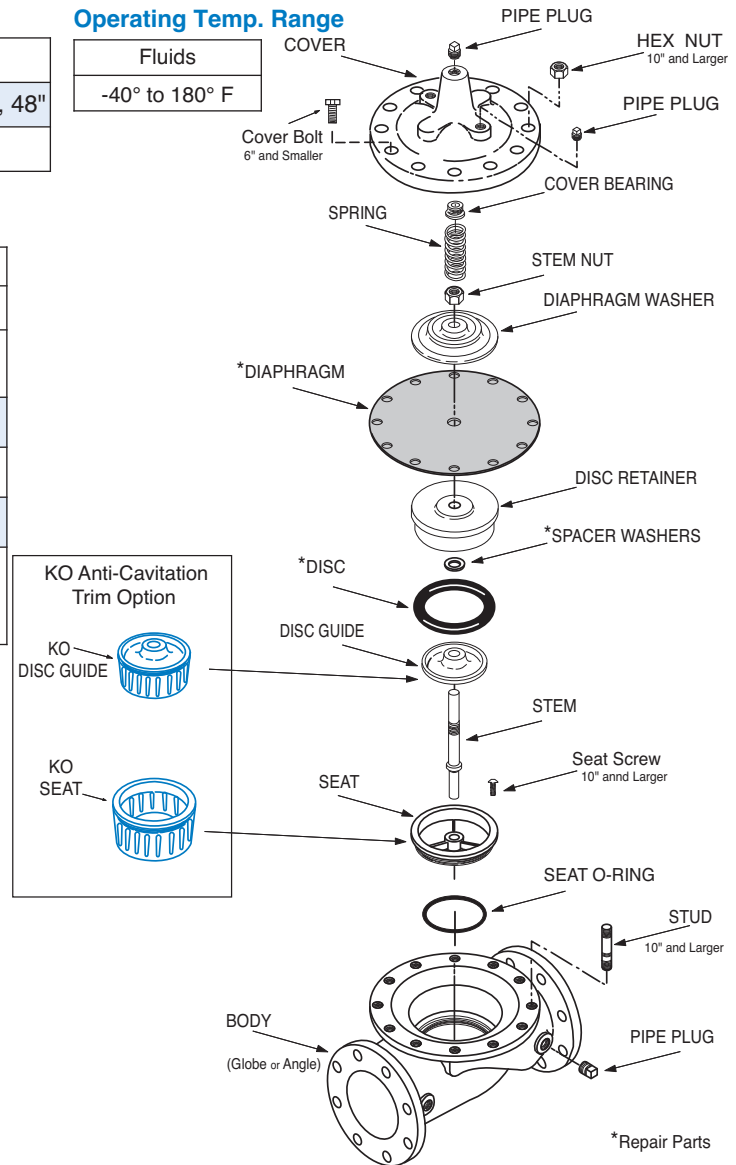

*Repair Parts

Heavy Spring - suffix KH

The heavy spring option is used in applications where there is low differential pressure across the valve, and the additional spring force is needed to help the valve close. This option is best suited for valves used in on-off (non-modulating) service.

Anti-Cavitation Trim - suffix KO

Anti-Cavitation Trim components consist of a stainless steel radial slotted disc guide and seat. This system is used when high differentials are present across the valve.

Water Treatment Clearance - suffix KW

This additional clearance is beneficial in applications where water treatment compounds can interfere with the closing of the valve. The smaller outside diameter disc guide provides more clearance between the disc guide and the valve seat. This option is best suited for valves used in on-off (non-modulating) service.

Functional Data

Model 100-20

Valve Size		Inches	3	4	6	8	10	12	14	16	18	20	24	30	36	42	48
		mm.	80	100	150	200	250	300	350	400	460	500	600	750	900	1000	1200
C_V Factor	Globe Pattern	Gal./Min. (gpm.)	62	136	229	480	930	1458	1725	2110	3250	3400*	4020	7900*	11910*	14500*	15800*
		Litres/Sec. (l/s.)	15	32.5	55	115	223	350	414	506	705	816	966	1895	2858	3483	3796
	Angle Pattern	Gal./Min. (gpm.)	—	135	233	545	CF**	CF**	CF**	CF**	CF**	CF**	CF**	—	—	—	—
		Litres/Sec. (l/s.)	—	32	56	132	CF**	CF**	CF**	CF**	CF**	CF**	CF**	—	—	—	—
Equivalent Length of Pipe	Globe Pattern	Feet (ft.)	293	251	777	748	621	654	750	977	983	1125	3005	2130	2862	4232	7028
		Meters (m.)	89.3	76.4	237.1	228.1	189.5	199.4	229	298	300	343	917	650	872	1290	2142
	Angle Pattern	Feet (ft.)	—	254	751	580	CF**	CF**	CF**	CF**	CF**	CF**	CF**	—	—	—	—
		Meters (m.)	—	77.6	229	176.9	CF**	CF**	CF**	CF**	CF**	CF**	CF**	—	—	—	—
K Factor	Globe Pattern		20.6	12.7	23.1	15.7	10.4	8.5	8.9	10.2	6.9	9.78	14.5	10.5	8.9	11.4	17.8
	Angle Pattern		—	12.9	22.3	12.2	CF**	CF**	CF**	CF**	CF**	CF**	CF**	—	—	—	—
Liquid Displaced from Cover Chamber When Valve Opens	Fl. Oz		—	—	—	—	—	—	—	—	—	—	—	—	—	—	—
	U.S. Gal.		0.32	.08	.17	.53	1.26	2.51	4.0	4.0	9.6	9.6	9.6	29.0	42	90	90
	ml		—	—	—	—	—	—	—	—	—	—	—	—	—	—	—
	Litres		.12	.30	.64	2.0	4.8	9.5	15.1	15.1	36.2	36.2	36.2	110	197	340	340

**Consult Factory

*Estimated

C_V Factor

Formulas for computing C_V Factor, Flow (Q) and Pressure Drop (ΔP):

$$C_V = \frac{Q}{\sqrt{\Delta P}} \quad Q = C_V \sqrt{\Delta P} \quad \Delta P = \left(\frac{Q}{C_V} \right)^2$$

K Factor (Resistance Coefficient)

The Value of K is calculated from the formula: $K = \frac{894d^4}{C_V^2}$ (U.S. system units)

Equivalent Length of Pipe

Equivalent lengths of pipe (L) are determined from the formula: $L = \frac{Kd}{12f}$ (U.S. system units)

Fluid Velocity

Fluid velocity can be calculated from the following formula: $V = \frac{.4085 Q}{d^2}$ (U.S. system units)

Where:

C_V = U.S. (gpm) @ 1 psi differential at 60° F water
or
= (l/s) @ 1 bar (14.5 PSIG) differential at 15° C water

d = inside pipe diameter of Schedule 40 Steel Pipe (inches)

f = friction factor for clean, new Schedule 40 pipe (dimensionless) (from Cameron Hydraulic Data, 18th Edition, P 3-119)

K = Resistance Coefficient (calculated)

L = Equivalent Length of Pipe (feet)

Q = Flow Rate in U.S. (gpm) or (l/s)

V = Fluid Velocity (feet per second) or (meters per second)

ΔP = Pressure Drop in (psi) or (bar)

Model 100-20 Flow Chart (Based on normal flow through a wide open valve)

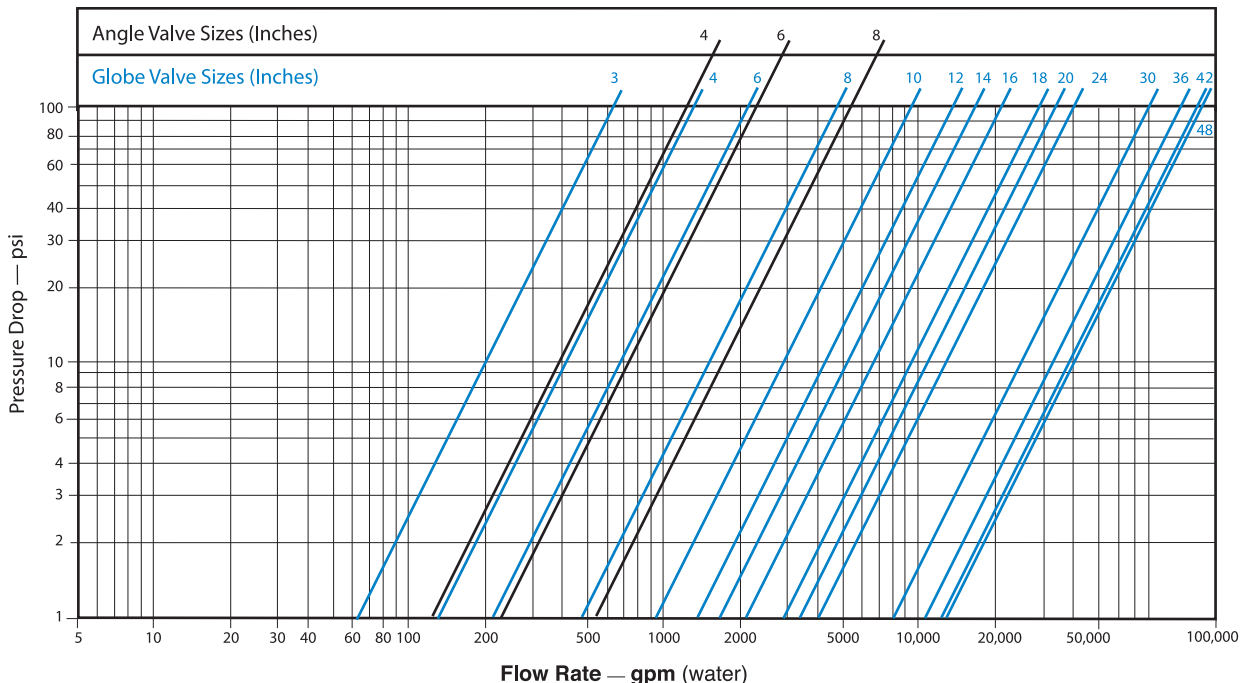

Dimensions

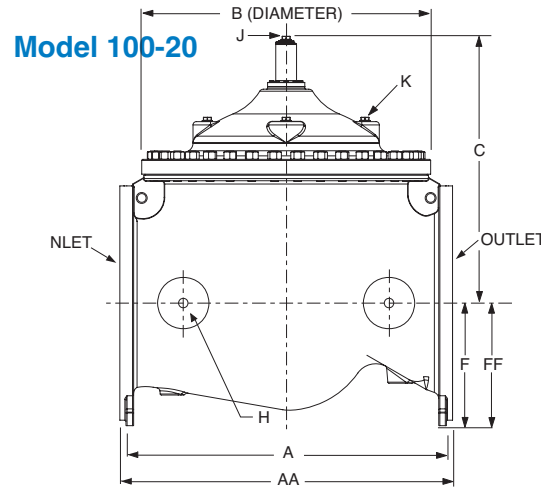
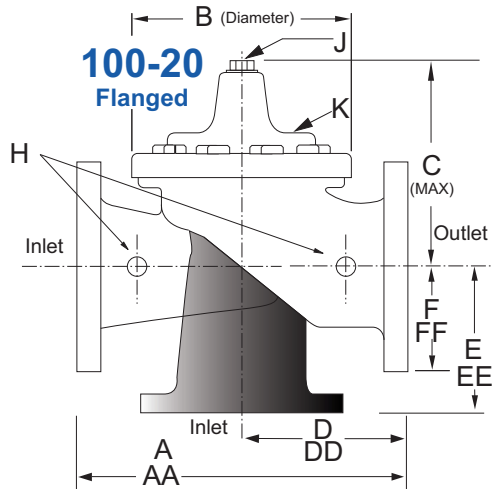

Valve Size (Inches)	3	4	6	8	10	12	14	16	18†	20†	24†	30†	36†	48†
A 150 ANSI	10.25	13.88	17.75	21.38	26.00	30.00	34.25	35.00	42.12	48.00	48.00	63.25	65.00	88.0
AA 300 ANSI	11.00	14.50	18.62	22.38	27.38	31.50	35.75	36.62	43.63	49.62	49.75	63.75	67.00	90.62
B Diameter	6.62	9.12	11.50	15.75	20.00	23.62	27.47	28.00	35.44	35.44	35.44	53.19	56.00	66.00
C Maximum	7.00	8.62	11.62	15.00	17.88	21.00	20.88	25.75	25.00	31.50	31.50	43.94	54.75	59.00
D 150 ANSI	—	6.94	8.88	10.69	CF*	17.00	CF*	CF*	CF*	CF*	21.06	—	—	—
DD 300 ANSI	—	7.25	9.38	11.19	CF*	17.75	CF*	CF*	CF*	CF*	CF*	—	—	—
E 150 ANSI	—	5.50	6.75	7.25	CF*	13.75	CF*	CF*	CF*	CF*	15.94	—	—	—
EE 300 ANSI	—	5.81	7.25	7.75	CF*	14.75	CF*	CF*	CF*	CF*	CF*	—	—	—
F 150 ANSI	3.75	4.50	5.50	6.75	8.00	9.50	11.00	11.75	15.88	14.56	17.00	19.88	25.50	34.00
FF 300 ANSI	4.12	5.00	6.25	7.50	8.75	10.25	11.50	12.75	15.88	16.06	19.00	22.00	27.50	38.50
H NPT Body Tapping	0.375	0.50	0.75	0.75	1.00	1.00	1.00	1.00	1.00	1.00	1.00	1.00	2.00	2.00
J NPT Cover Center Plug	0.50	0.50	0.75	0.75	1.00	1.00	1.25	2.00	2.00	2.00	2.00	2.00	2.00	2.00
K NPT Cover Tapping	0.375	0.50	0.75	0.75	1.00	1.00	1.00	1.00	1.00	1.00	1.00	1.00	2.00	2.00
Stem Travel	0.60	0.80	1.10	1.70	2.30	2.80	3.40	4.50	4.50	4.50	6.50	7.50	7.50	8.50
Approx. Ship Weight (lbs)	45	85	195	330	625	900	1250	1380	2365	2551	2733	6500	8545	13100

Note: The top two flange holes on valve sizes 36 thru 48 are threaded to 1 1/2"-6 UNC.

CF* - Consult Factory

†100-20 series Hytrol valves are equipped with flange feet for safety and convenience. Consult Cla-Val representative for details.

For assistance in selecting appropriate valve options or valves manufactured with special design requirements, please contact our Regional Sales Office or Factory.

Service and Installation

Cla-Val Control Valves operate with maximum efficiency when mounted in horizontal piping with the main valve cover UP, however, other positions are acceptable. Due to component size and weight of 10 inch and larger valves, installation with cover UP is advisable. We recommend isolation valves be installed on inlet and outlet for maintenance. Adequate space above and around the valve for service personnel should be considered essential. A regular maintenance program should be established based on the specific application data. However, we recommend a thorough inspection be done at least once a year. Consult factory for specific recommendations.



CLA-VAL

1701 Placentia Avenue • Costa Mesa, CA 92627
 800-942-6326 • Fax: 949-548-5441 • Web Site: cla-val.com • E-mail: info@cla-val.com

CLA-VAL CANADA

4687 Christie Drive
 Beamsville, Ontario
 Canada L0R 1B4
 Phone: 905-563-4963
 E-mail sales@cla-val.ca

CLA-VAL EUROPE

Chemin des Mésanges 1
 CH-1032 Romanel/
 Lausanne, Switzerland
 Phone: 41-21-643-15-55
 E-mail: cla-val@cla-val.ch

CLA-VAL UK

Dainton House, Goods Station Road
 Tunbridge Wells
 Kent TN1 2 DH England
 Phone: 44-1892-514-400
 E-mail: info@cla-val.co.uk

CLA-VAL FRANCE

Porte du Grand Lyon 1
 ZAC du Champ du Périer
 France - 01700 Neyron
 Phone: 33-4-72-25-92-93
 E-mail: cla-val@cla-val.fr

CLA-VAL PACIFIC

45 Kennaway Road
 Woolston, Christchurch, 8023
 New Zealand
 Phone: 64-39644860
 www.cla-valpacific.com
 E-mail: info@cla-valpacific.com

visit www.cla-val-latinamerica.com for Spanish literature