

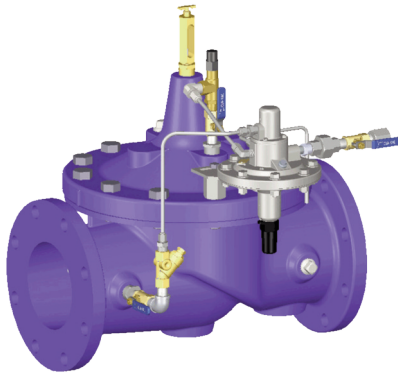

Altitude Valve For One-Way Flow



- Accurate and Repeatable Level Control
- Drip-Tight Positive Shut-Off
- Reliable Hydraulic Operation
- Easily Adjustable Control
- Completely Automatic Operation

The Cla-Val Model 211-01 Altitude Valve controls the high water level in reservoirs without the need for floats or other devices. It is a non-throttling valve that remains fully open until the shut-off point is reached. This valve is designed for one-way flow only.

This valve is hydraulically operated and pilot controlled. The pilot control operates on the differential in forces between a spring load and the water level in the reservoir. When the force of the spring is overcome by the force of the reservoir head, the pilot closes the main valve. The desired high water level is set by adjusting the spring force. The pilot control measures the reservoir head through a customer supplied sensing line* connected directly to the reservoir.

This valve can also be furnished with auxiliary controls to meet the need for multiple functions, such as: pressure sustaining, pressure reduction, rate of flow control, solenoid override, etc. For applications requiring delayed opening, please refer to Cla-Val Model 211-03 Altitude Valve with Delayed Opening e-sheet.

Schematic Diagram

Item	Description
1	100-01 Hytrol Main Valve
2	CDS7 Altitude Control
3	X101 Valve Position Indicator
4	Bell Reducer
5	CV Flow Control (Closing)
6	CK2 Isolation Valve
7	Union

Optional Features

Item	Description
A	X46A Flow Clean Strainer
B	CK2 Isolation Valve
D	Check Valve with Cock
F	Independent Operating Pressure
H	Dry Drain
P	X141 Pressure Gauge
R	Reservoir Gauge with Tester
S	CV Flow Control (Opening)
Y	X43 "Y" Strainer

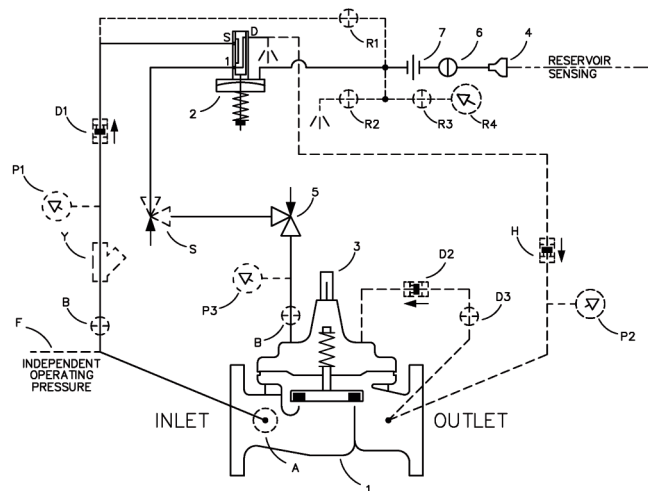

Note: When "D" check feature is ordered, the "H" feature is required.

Typical Applications

Used on reservoirs where the water is withdrawn through a separate line or through a bypass equipped with a check valve. The valve opens to refill the reservoir when the water lowers below the shut-off level. For more information see data sheet E-CDS7.

Notes:

- The reservoir pressure sensing line should be 3/4" minimum I.D. installed with a 2° slope from valve to reservoir to avoid air pockets.
- The sensing line should not be installed in the flowing line between the valve and the reservoir or into a turbulent flow area. These locations do not reflect the true static head of the reservoir.
- We recommend protecting tubing and valve from freezing temperatures.

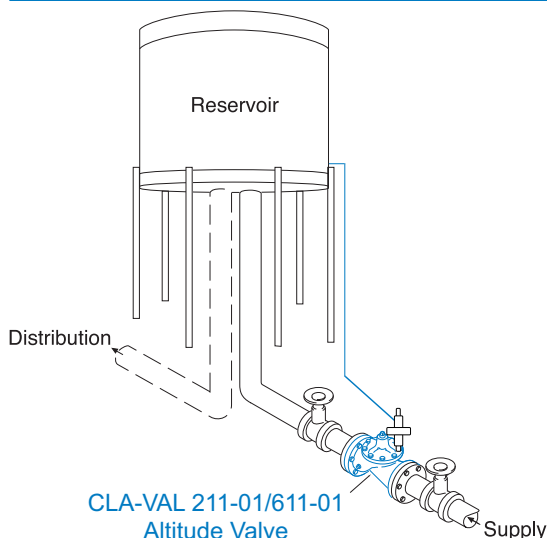

Model 211-01 (Uses 100-01 Hytrol Main Valve)

Pressure Ratings (Recommended Maximum Pressure - psi)

Valve Body & Cover		Pressure Class				
		Flanged			Grooved	Threaded
Grade	Material	ANSI Standards*	150 Class	300 Class	300 Class	End‡ Details
ASTM A536	Ductile Iron	B16.42	250	400	400	400
ASTM A216-WCB	Cast Steel	B16.5	285	400	400	400
UNS 87850	Bronze	B16.24	225	400	400	400

Note: * ANSI standards are for flange dimensions only.
 Flanged valves are available faced but not drilled.
 ‡ End Details machined to ANSI B2.1 specifications.
Valves for higher pressure are available; consult factory for details

Materials

Component	Standard Material Combinations		
Body & Cover	Ductile Iron	Cast Steel	Bronze
Available Sizes	2" - 36" 50 - 900 mm	2" - 16" 400 - 900 mm	2" - 16" 400 - 900 mm
Disc Retainer & Diaphragm Washer	Cast Iron	Cast Steel	Bronze
Trim: Disc Guide, Seat & Cover Bearing	Bronze is Standard Stainless Steel is Optional		
Disc	Buna-N® Rubber		
Diaphragm	Nylon Reinforced Buna-N® Rubber		
Stem, Nut & Spring	Stainless Steel		

For material options not listed, consult factory.
 Cla-Val manufactures valves in more than 50 different alloys.

Cover Capacity

Liquid Volume Displaced from Diaphragm Chamber When Valve Opens or Closes

Valve Size	Displacement
2"	.032 gal
2 1/2"	.043 gal
3"	.080 gal
4"	.169 gal
6"	.531 gal
8"	1.26 gal
10"	2.51 gal
12"	4.00 gal
14"	6.50 gal
16"	9.57 gal
18"	11.00 gal
20"	12.00 gal
24"	29.00 gal
36"	90.00 gal

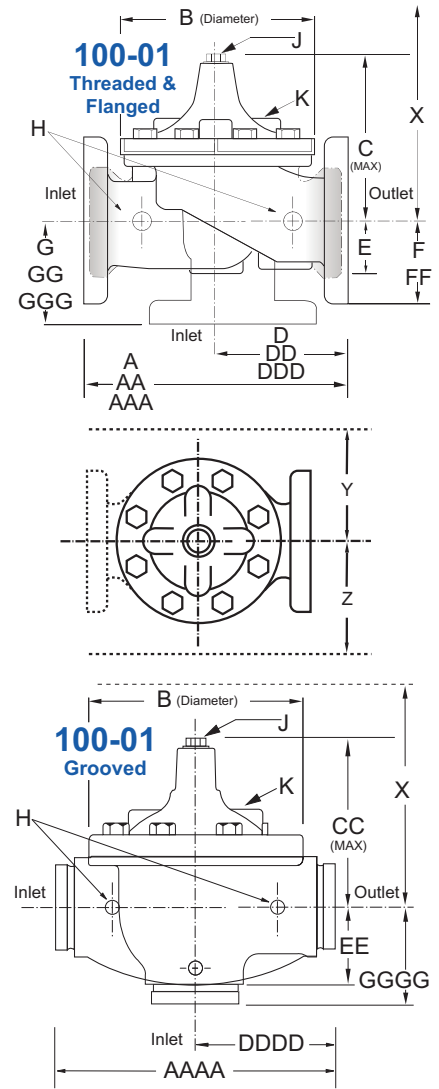

Model 211-01 Dimensions (In Inches)

Valve Size (Inches)	2	2 1/2	3	4	6	8	10	12	14	16	18	20	24	30	36
A Threaded	9.38	11.00	12.50	—	—	—	—	—	—	—	—	—	—	—	—
AA 150 ANSI	9.38	11.00	12.00	15.00	20.00	25.38	29.75	34.00	39.00	41.38	46.00	52.00	61.50	63.00	72.75
AAA 300 ANSI	10.00	11.62	13.25	15.62	21.00	26.38	31.12	35.50	40.50	43.50	47.64	53.62	63.24	64.50	74.75
AAAA Grooved End	9.00	11.00	12.50	15.00	20.00	25.38	—	—	—	—	—	—	—	—	—
B Diameter	6.62	8.00	9.12	11.50	15.75	20.00	23.62	28.00	32.75	35.50	41.50	45.00	53.16	56.00	66.00
C Maximum	6.50	7.56	8.19	10.62	13.38	16.00	17.12	20.88	24.19	25.00	39.06	41.90	43.93	54.60	59.00
CC Maximum Grooved End	5.75	6.88	7.25	9.31	12.12	14.62	—	—	—	—	—	—	—	—	—
D Threaded	4.75	5.50	6.25	—	—	—	—	—	—	—	—	—	—	—	—
DD 150 ANSI	4.75	5.50	6.00	7.50	10.00	12.69	14.88	17.00	19.50	20.81	—	—	30.75	—	—
DDD 300 ANSI	5.00	5.88	6.38	7.88	10.50	13.25	15.56	17.75	20.25	21.62	—	—	31.62	—	—
DDDD Grooved End	4.75	—	6.00	7.50	—	—	—	—	—	—	—	—	—	—	—
E	1.50	1.69	2.06	3.19	4.31	5.31	9.25	10.75	12.62	15.50	12.95	15.00	17.75	21.31	24.56
EE Grooved End	2.50	2.88	3.12	4.25	6.00	7.56	—	—	—	—	—	—	—	—	—
F 150 ANSI	3.00	3.50	3.75	4.50	5.50	6.75	8.00	9.50	10.50	11.75	15.00	16.50	19.25	22.50	28.50
FF 300 ANSI	3.25	3.75	4.13	5.00	6.25	7.50	8.75	10.25	11.50	12.75	15.00	16.50	19.25	24.00	30.00
G Threaded	3.25	4.00	4.50	—	—	—	—	—	—	—	—	—	—	—	—
GG 150 ANSI	3.25	4.00	4.00	5.00	6.00	8.00	8.62	13.75	14.88	15.69	—	—	22.06	—	—
GGG 300 ANSI	3.50	4.31	4.38	5.31	6.50	8.50	9.31	14.50	15.62	16.50	—	—	22.90	—	—
GGGG Grooved End	3.25	—	4.25	5.00	—	—	—	—	—	—	—	—	—	—	—
H NPT Body Tapping	0.375	0.50	0.50	0.75	0.75	1.00	1.00	1.00	1.00	1.00	1.00	1.00	1.00	2.00	2.00
J NPT Cover Center Plug	0.50	0.50	0.50	0.75	0.75	1.00	1.00	1.25	1.50	2.00	1.00	1.00	1.00	2.00	2.00
K NPT Cover Tapping	0.375	0.50	0.50	0.75	0.75	1.00	1.00	1.00	1.00	1.00	1.00	1.00	1.00	2.00	2.00
Stem Travel	0.60	0.70	0.80	1.10	1.70	2.30	2.80	3.40	4.00	4.50	5.10	5.63	6.75	7.50	8.50
Approx. Ship Weight (lbs)	35	50	70	140	285	500	780	1165	1600	2265	2982	3900	6200	7703	11720
Approx. X Pilot System	13	14	15	17	29	31	33	36	40	40	43	47	68	79	85
Approx. Y Pilot System	9	10	11	12	20	22	24	26	29	30	32	34	39	40	45
Approx. Z Pilot System	9	10	11	12	20	22	24	26	29	30	32	34	39	42	47

Model 211-01 Metric Dimensions (Uses Main Valve Model 100-01)

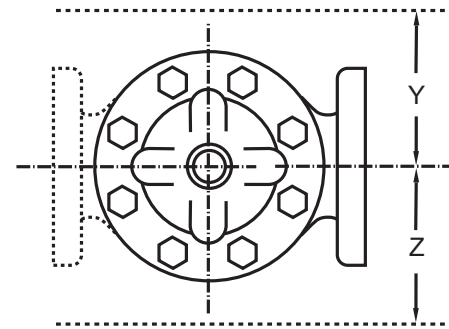
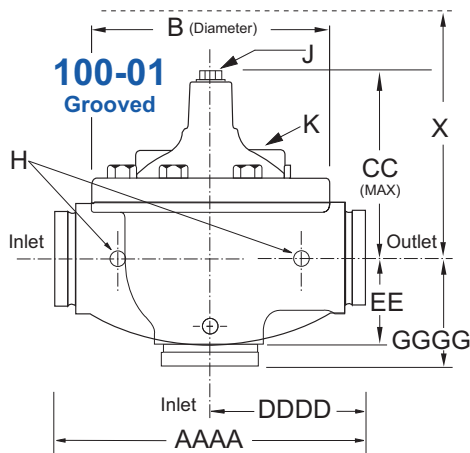
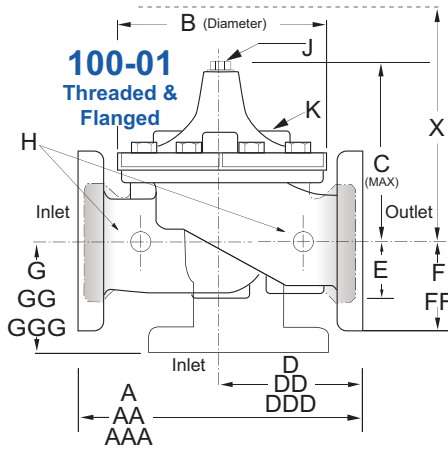

211-01 Dimensions (in mm)

Valve Size (mm)	50	65	80	100	150	200	250	300	350	400	450	500	600	750	900
A Threaded	238	279	318	—	—	—	—	—	—	—	—	—	—	—	—
AA 150 ANSI	238	279	305	381	508	645	756	864	991	1051	1168	1321	1562	1600	1848
AAA 300 ANSI	254	295	337	397	533	670	790	902	1029	1105	1210	1326	1606	1638	1899
AAAA Grooved End	228	279	318	381	508	645	—	—	—	—	—	—	—	—	—
B Diameter	168	203	232	292	400	508	600	711	832	902	1054	1143	1350	1422	1676
C Maximum	165	192	208	270	340	406	435	530	614	635	992	1064	1116	1387	1499
CC Maximum Grooved End	146	175	184	236	308	371	—	—	—	—	—	—	—	—	—
D Threaded	121	140	159	—	—	—	—	—	—	—	—	—	—	—	—
DD 150 ANSI	121	140	152	191	254	322	378	432	495	528	—	—	781	—	—
DDD 300 ANSI	127	149	162	200	267	337	395	451	514	549	—	—	803	—	—
DDDD Grooved End	121	—	152	191	—	—	—	—	—	—	—	—	—	—	—
E	38	43	52	81	110	135	235	273	321	394	329	381	451	541	624
EE Grooved End	64	73	79	108	152	192	—	—	—	—	—	—	—	—	—
F 150 ANSI	76	89	95	114	140	171	203	241	267	298	381	419	489	572	724
FF 300 ANSI	83	95	105	127	159	191	222	260	292	324	381	419	489	610	762
G Threaded	83	102	114	—	—	—	—	—	—	—	—	—	—	—	—
GG 150 ANSI	83	102	102	127	152	203	219	349	378	399	—	—	560	—	—
GGG 300 ANSI	89	110	111	135	165	216	236	368	397	419	—	—	582	—	—
GGGG Grooved End	83	—	108	127	—	—	—	—	—	—	—	—	—	—	—
H NPT Body Tapping	0.375	0.50	0.50	0.75	0.75	1.00	1.00	1.00	1.00	1.00	1.00	1.00	1.00	2.00	2.00
J NPT Cover Center Plug	0.50	0.50	0.50	0.75	0.75	1.00	1.00	1.25	1.50	2.00	1.00	1.00	1.00	2.00	2.00
K NPT Cover Tapping	0.375	0.50	0.50	0.75	0.75	1.00	1.00	1.00	1.00	1.00	1.00	1.00	1.00	2.00	2.00
Stem Travel	15	18	20	28	43	58	71	86	102	114	130	143	171	190	216
Approx. Ship Weight (kgs)	16	23	32	64	129	227	354	528	726	1027	1353	1769	2812	3494	5316
Approx. X Pilot System	331	356	381	432	737	788	839	915	1016	1016	1093	1194	1728	2007	2159
Approx. Y Pilot System	229	254	280	305	508	559	610	661	737	762	813	864	991	1016	1143
Approx. Z Pilot System	229	254	280	305	508	559	610	661	737	762	813	864	991	1067	1194

211-01 Valve Selection	100-01 Pattern: Globe (G), Angle (A), End Connections: Threaded (T), Grooved (GR), Flanged (F) Indicate Available Sizes															
	Inches	2	2½	3	4	6	8	10	12	14	16	18	20	24	30	36
	mm	50	65	80	100	150	200	250	300	350	400	450	500	600	750	900
Main Valve 100-01	Pattern	G, A	G, A	G, A	G, A	G, A	G, A	G, A	G, A	G, A	G, A	G	G	G, A	G	G
	End Detail	T, F, Gr	T, F, Gr*	T, F, Gr	F, Gr	F, Gr*	F, Gr*	F	F	F	F	F	F	F	F	F
Suggested Flow (gpm)	Maximum	210	300	460	800	1800	3100	4900	7000	8400	11000	14000	17000	25000	42000	50000
	Maximum Intermittent	260	370	580	990	2250	3900	6150	8720	10540	13700	17500	21700	31300	48000	62500
Suggested Flow (Liters/Sec)	Maximum	13	19	29	50	113	195	309	442	530	694	883	1073	1577	2650	3150
	Maximum Intermittent	16	23	37	62	142	246	387	549	664	863	1104	1369	1972	3028	3940

100-01 Series is the full internal port Hytrol. *Globe Grooved Only

Pilot System Specifications

Adjustment Ranges

- 5 - 40 ft. / 1 - 12m - Standard
- 10 - 80 ft. / 3 - 24m - Optional
- 10 - 150 ft. / 3 - 45m - Optional

Temperature Range

Water: to 180°F

If flowing line pressure is less than 10 psi, consult factory for full details.

If inlet pressure is above 150 psi, consult factory for recommendations.

Materials

Standard Pilot System Materials

- Pilot Control: 303 Stainless Steel
- Trim: Stainless Steel Type 303
- Rubber: Buna-N® Synthetic Rubber

Valve position indicator is standard.

Altitude Pilot Control Overview

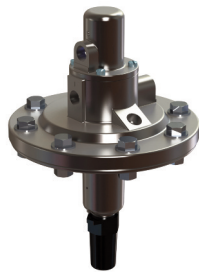

- **Very Accurate and Reliable**
- **Low Maintenance**
- **Stainless Steel Wetted Parts**

The Cla-Val Model CDS7 Altitude Pilot Control is a spring-loaded, three-way, diaphragm-actuated control that provides high-level shutoff for Cla-Val 211 Series Altitude Control Valves. The CDS7 controls the high water level in a reservoir or tank without the need for floats or other devices. It is a non-throttling pilot that remains fully open until the reservoir reaches the high level shutoff point. High accuracy is assured by remotely sensing the pressure head of the reservoir or tank. The single adjusting screw can be easily set in the field to close the main valve when liquid level reaches the desired high level set-point within standard adjustment range.

The CDS7 operating principle uses a differential in forces between the spring load and the hydraulic head of the fluid level in the reservoir or tank to activate the pilot valve of the control. When the force of the spring setting (or the desired high level shutoff point) is overcome by the force of the reservoir head, the pilot valve shifts positions automatically and closes the main valve. When the reservoir head is eight to ten inches less than the spring setting, the pilot valve shifts to open the main valve.

When Ordering, Specify

1. Catalog No. 211-01
2. Valve Size
3. Pattern - Globe or Angle
4. Pressure Class
5. Threaded, Flanged or Grooved
6. Materials Desired
7. Adjustment Range
8. Desired Options
9. When Vertically Installed

**For a comprehensive overview of Cla-Val
Altitude Control Valves, please
visit www.cla-val.com and use
keyword search "Altitude".**



CLA-VAL

1701 Placentia Avenue • Costa Mesa, CA 92627

800-942-6326 • Fax: 949-548-5441 • Web Site: cla-val.com • E-mail: info@cla-val.com

CLA-VAL CANADA

4687 Christie Drive
Beamsville, Ontario
Canada L0R 1B4
Phone: 905-563-4963
E-mail sales@cla-val.ca

CLA-VAL EUROPE

Chemin des Mésanges 1
CH-1032 Romanel/
Lausanne, Switzerland
Phone: 41-21-643-15-55
E-mail: cla-val@cla-val.ch

CLA-VAL UK

Dainton House, Goods Station Road
Tunbridge Wells
Kent TN11 2 DH England
Phone: 44-1892-514-400
E-mail: info@cla-val.co.uk

CLA-VAL FRANCE

Porte du Grand Lyon 1
ZAC du Champ du Périer
France - 01700 Neyron
Phone: 33-4-72-25-92-93
E-mail: cla-val@cla-val.fr

CLA-VAL PACIFIC

45 Kennaway Road
Woolston, Christchurch, 8023
New Zealand
Phone: 64-39644860
www.cla-valpacific.com
E-mail: info@cla-valpacific.com