



— MODEL — **CFC2**

# Float Control For Closed Tanks



- **Accurate Liquid Level Control**
- **Fully Hydraulic Operation**
- **Simple Design, Easy Maintenance**
- **No Lubrication Necessary**
- **No Gears, No Mechanical Linkage Between Valve and Control**

The Cla-Val Model CFC2 Float Control is a float-actuated, multi-port pilot control which provides non-modulating, two-position, on-off operation. It is used primarily to operate remotely located Cla-Val Valves requiring three-way or four-way pilot valve operation. Designed for use in closed tanks, this control operates on a minimum level change of approximately one inch. Maximum level change of five and one-half inches is needed for full capacity.

Note: We recommend protecting the control tubing and valve from freezing temperatures.

## Specifications

<b>Control Piping Connections</b>	1/8" NPT
<b>Reservoir Connections</b>	1" NPT
<b>Pressure Rating</b>	0-150 psi
<b>Temperature Rating</b>	Water: to 180°F.
<b>Materials</b>	In contact with operating fluid: Brass, Stainless Steel, Monel, with Buna-N® Seals Float chamber: Cast Iron Pilot valve housing: Bronze Materials in contact with operating fluid: Brass, Stainless Steel, Monel with Buna-N® Seals Float ball: Stainless Steel Float arm: Brass Other material available: Cast steel or aluminum chamber and pilot valve housing. All stainless steel
<b>Level Differential</b>	Approximately 1" minimum required to change pilot valve operation. 5 5/8" required to develop full capacity.
<b>Operating Fluids</b>	Clean liquids or gases compatible with specified materials.
<b>Shipping Weight</b>	12 lbs.

## Dimensions (In Inches)

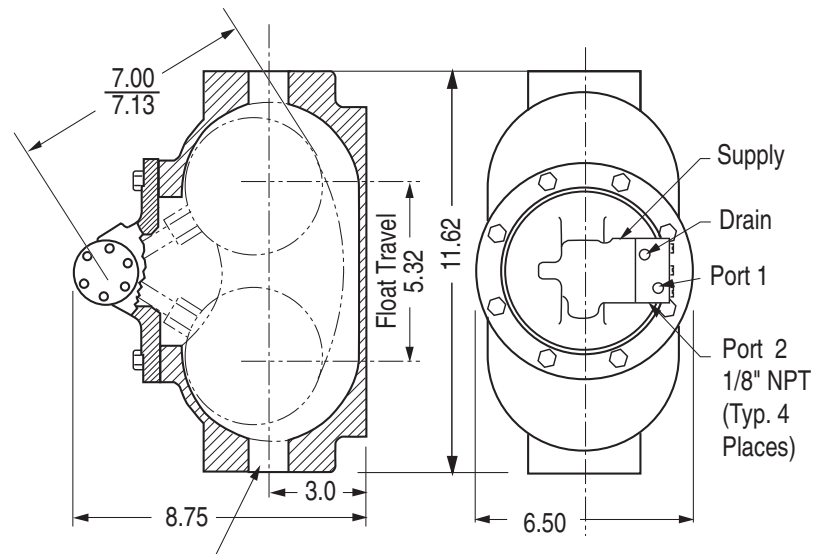

Reservoir Connection  
1" NPT (Typ. Both Ends 2 Places)

## Installation Data

The float control is mounted at the high water level in the tank. The remote Cla-Val valve is installed in the line leading to the tank and is connected to the float control pilot by tubing. (Min. 3/8" for valves 6" and smaller, 3/4" or larger for valves 8" or larger.)

When line pressure is used to operate the valve, tubing connections are made from the float control pilot to the valve cover, and also to the inlet side of the valve. An X46 Flow Clean Strainer must be installed in the inlet side of the valve. The control may be installed at any elevation above the valve, providing that the flowing line pressure in psi is equal to, or

greater than, the vertical distance in feet between the valve and the float control.

An independent source of air or water may be used to operate the valve. The pressure from this independent source must constantly be equal to or greater than pressure at the valve inlet. The independent source is connected to the float control pilot in place of the supply line connected to the inlet side of the valve. If the Model 100-01 under the control of the CFC2 is 8" or larger, auxiliary Hytrol valves may be required. Consult factory for details.

Note: We recommend protecting the control tubing and valve from freezing temperatures.

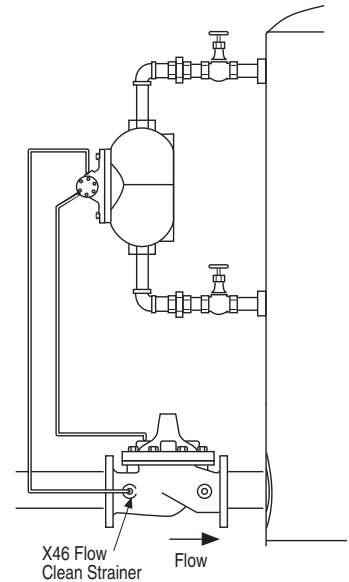

### For Controlling Hytrol Valve

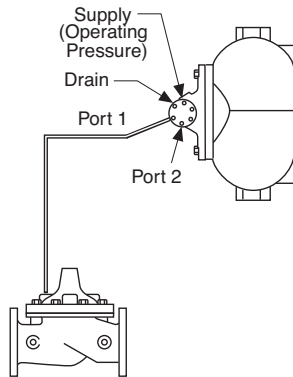

Float Up Closes Valve

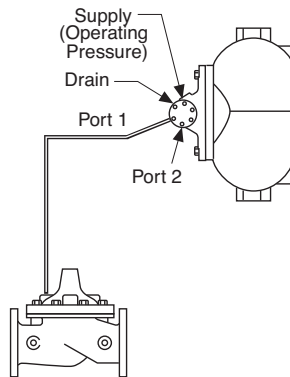

Float Down Closes Valve

### When Ordering, Please Specify

1. Catalog No. CFC2-C1
2. Size and Type of Valve to be Controlled.
3. Materials if different from standard
4. Specify Gravity of Fluid if other than Water.

### For Controlling Powertrol Valves

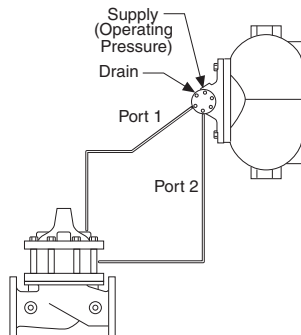

Float Up Closes Valve

Float Down Closes Valve

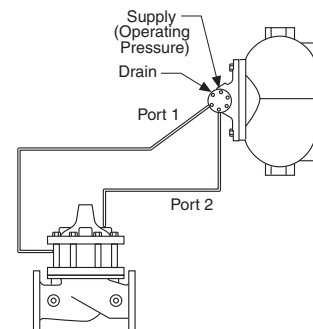

### For Controlling Two Valves Simultaneously

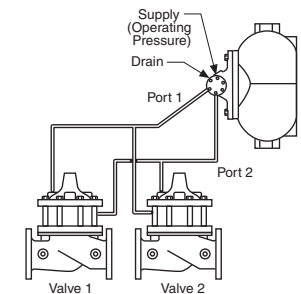

Valve 1 Valve 2

#### Operation

Float Position	Valve 1	Valve 2
UP	CLOSED	OPEN
DOWN	OPEN	CLOSED

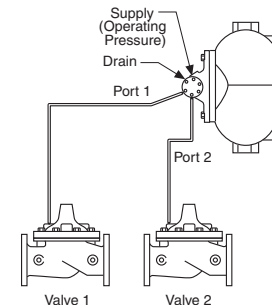

Valve 1 Valve 2



E-CFC2 (R-09/2018)

## CLA-VAL

1701 Placentia Avenue • Costa Mesa, CA 92627

800-942-6326 • Fax: 949-548-5441 • Web Site: [cla-val.com](http://cla-val.com) • E-mail: [info@cla-val.com](mailto:info@cla-val.com)

**CLA-VAL CANADA**  
4687 Christie Drive  
Beamsville, Ontario  
Canada L0R 1B4  
Phone: 905-563-4963  
Fax: 905-563-4040  
E-mail [sales@cla-val.ca](mailto:sales@cla-val.ca)

**CLA-VAL EUROPE**  
Chemin des Mésanges 1  
CH-1032 Romanel/  
Lausanne, Switzerland  
Phone: 41-21-643-15-55  
Fax: 41-21-643-15-50  
E-mail: [cla-val@cla-val.ch](mailto:cla-val@cla-val.ch)

**CLA-VAL UK**  
Dainton House, Goods Station Road  
Tunbridge Wells  
Kent TN11 2 DH England  
Phone: 44-1892-514-400  
Fax: 44-1892-543-423  
E-mail: [info@cla-val.co.uk](mailto:info@cla-val.co.uk)

**CLA-VAL FRANCE**  
Porte du Grand Lyon 1  
ZAC du Champ du Périer  
France - 01700 Neyron  
Phone: 33-4-72-25-92-93  
Fax: 33-4-72-25-04-17  
E-mail: [cla-val@cla-val.fr](mailto:cla-val@cla-val.fr)

©COPYRIGHT CLA-VAL 2018 Printed in USA Specifications subject to change without notice.