



— MODEL — **631-22**

Electronic Interface Control Valve



- **Simple Proven Design**
- **Valve Closes Upon Power Failure**
- **Quality Solenoid Pilot Controls**
- **Ideal For Scada Systems**
- **Multi-Function Capability; Hydraulic Backup**
- **Security System To Prevent Unauthorized Changes**

Cla-Val 631-22 Electronic Interface Control Valves are designed specifically for applications where remote control of the valve is preferred. It is a hydraulically operated, pilot controlled, diaphragm valve. The solenoid pilot controls are actuated by electrical signals from the optional VC-22D Electronic Valve Controller. The solenoid pilots either add or relieve line pressure from the cover chamber of the valve, causing it to open or close as directed by the electronic controller.

631-22 Electronic Control Valves can be configured to perform a wide range of functions, such as; pressure reducing, pressure sustaining, flow control, or level control. The electric controls can also be combined with hydraulic controls to create dual function, or fail-safe capability.

The 631-22 Electronic Control Valve (schematic shown below) includes the main valve and solenoid pilot controls. Optional features include the VC-22D Electronic Valve Controller and the X117 Series Valve Position Transmitter. If the check feature option is added, and a pressure reversal occurs, the downstream pressure is admitted into the cover, closing the control valve.

Schematic Diagram

Item	Description
1	100-20 Hytrol Main Valve
2	CS2 Solenoid Control
3	CK2 Solenoid Bypass Valve

Optional Features

Item	Description
A	X46A Flow Clean Strainer
B	CK2 Isolation Valve
C	CV Flow Control (Closing)
D	Check Valves With Isolation Valve
E	X117 Series Position Transmitter
F	Independent Operating Pressure
H	Atmospheric Drain
N	Electronic Controller
P	X141 Pressure Gauge
S	CV Flow Control (Opening)
Y	X43 "Y" Strainer

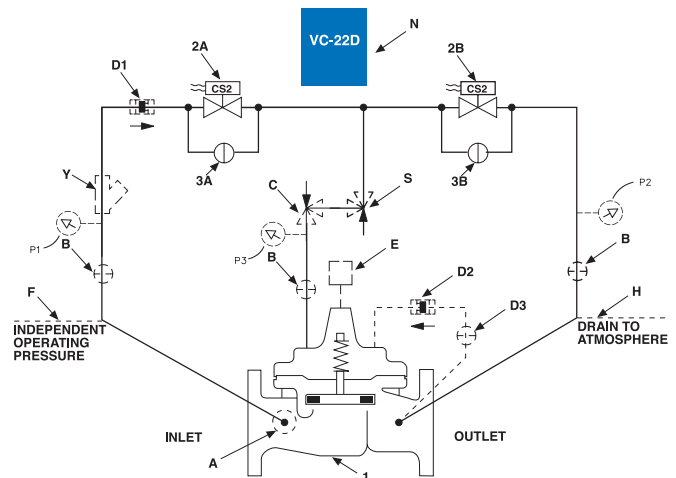

Typical Applications

The 631-22 is typically installed in a pipeline with a VC-22D Series Controller that receives a process variable signal and, in turn, compared to a set point to adjust the main valve's capacity until the signals match.

It is an Electronic Interface Valve with a power failure close feature, utilizing two direct-acting solenoid controls.

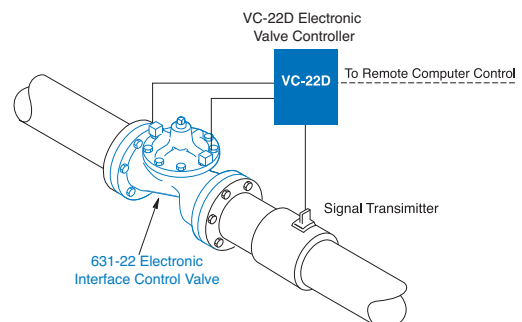

631-22 (Uses 100-20 Hytrol Main Valve)

Pressure Ratings (Recommended Maximum Pressure - psi)

Valve Body & Cover		Pressure Class		
		Flanged		
Grade	Material	ANSI Standards*	150 Class	300 Class
ASTM A536	Ductile Iron	B16.42	250	400
ASTM A216-WCB	Cast Steel	B16.5	285	400
UNS 87850	Bronze	B16.24	225	400

Note: * ANSI standards are for flange dimensions only.
 Flanged valves are available faced but not drilled.
Valves for higher pressure are available; consult factory for details

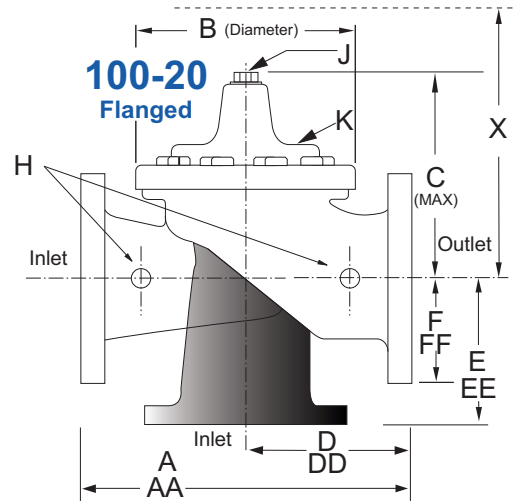

Materials

Component	Standard Material Combinations		
Body & Cover	Ductile Iron	Cast Steel	Bronze
Available Sizes	3" - 48" 80 - 1200mm	3" - 16" 80 - 400mm	3" - 16" 80 - 400mm
Disc Retainer & Diaphragm Washer	Cast Iron	Cast Steel	Bronze
Trim: Disc Guide, Seat & Cover Bearing	Bronze is Standard Stainless Steel is Optional		
Disc	Buna-N® Rubber		
Diaphragm	Nylon Reinforced Buna-N® Rubber		
Stem, Nut & Spring	Stainless Steel		

For material options not listed, consult factory.
 Cla-Val manufactures valves in more than 50 different alloys.

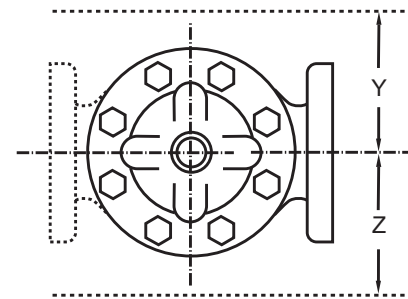

631-22 Dimensions (inches)

Valve Size (Inches)	3	4	6	8	10	12	14	16	18	20	24	30	36	48
A 150 ANSI	10.25	13.88	17.75	21.38	26.00	30.00	34.25	35.00	42.12	48.00	48.00	63.25	65.00	88.0
AA 300 ANSI	11.00	14.50	18.62	22.38	27.38	31.50	35.75	36.62	43.63	49.62	49.75	63.75	67.00	90.62
B Diameter	6.62	9.12	11.50	15.75	20.00	23.62	27.47	28.00	35.44	35.44	35.44	53.19	56.00	66.00
C Maximum	7.00	8.62	11.62	15.00	17.88	21.00	20.88	25.75	25.00	31.50	31.50	43.94	54.75	59.00
D 150 ANSI	—	6.94	8.88	10.69	12.75	14.94	—	—	20.93	21.06	—	—	—	—
DD 300 ANSI	—	7.25	9.38	11.19	—	—	—	—	—	—	—	—	—	—
E 150 ANSI	—	5.50	6.75	7.25	8.06	8.68	—	—	15.81	15.94	—	—	—	—
EE 300 ANSI	—	5.81	7.25	7.75	—	—	—	—	—	—	—	—	—	—
F 150 ANSI	3.75	4.50	5.50	6.75	8.00	9.50	11.00	11.75	15.88	14.56	17.00	19.88	25.50	34.00
FF 300 ANSI	4.12	5.00	6.25	7.50	8.75	10.25	11.50	12.75	15.88	16.06	19.00	22.00	27.50	38.50
H NPT Body Tapping	0.375	0.50	0.75	0.75	1.00	1.00	1.00	1.00	1.00	1.00	1.00	1.00	2.00	2.00
J NPT Cover Center Plug	0.50	0.50	0.75	0.75	1.00	1.00	1.25	1.25	2.00	2.00	2.00	1.00	2.00	2.00
K NPT Cover Tapping	0.375	0.50	0.75	0.75	1.00	1.00	1.00	1.00	1.00	1.00	1.00	1.00	2.00	2.00
Stem Travel	0.60	0.80	1.10	1.70	2.30	2.80	3.40	4.50	4.50	4.50	6.50	7.50	7.50	8.50
Approx. Ship Weight (lbs)	45	85	195	330	625	900	1250	1380	2365	2551	2733	6500	8545	13100
Approx. X Pilot System	13	15	27	30	33	36	36	41	40	46	55	68	79	86
Approx. Y Pilot System	10	11	18	20	22	24	26	26	30	30	30	39	40	47
Approx. Z Pilot System	10	11	18	20	22	24	26	26	30	30	30	39	42	49

*Consult Factory

631-22 Metric Dimensions (Uses 100-20 Hytrol Main Valve)

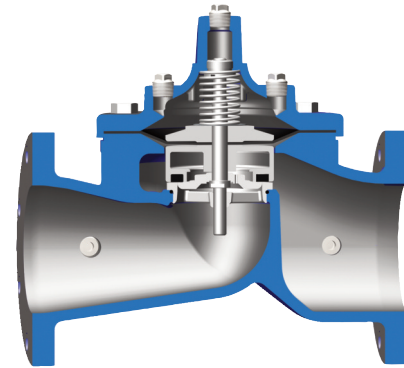
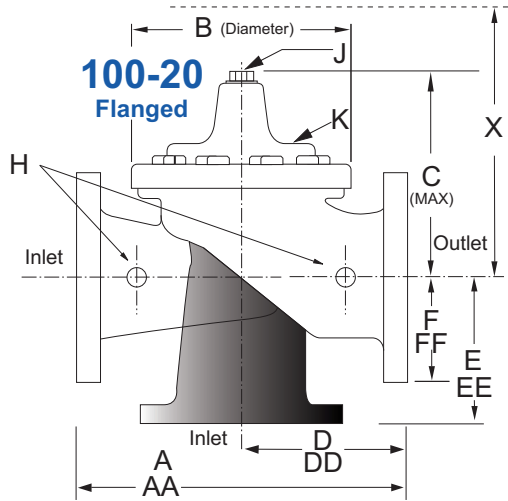

Model 100-20 Reduced Port Hytrol Main Valve

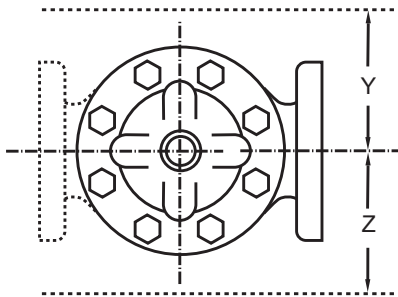

631-22 Dimensions (mm)

Valve Size (mm)	80	100	150	200	250	300	350	400	450	500	600	750	900	1200
A 150 ANSI	260	353	451	543	660	762	870	889	1070	1219	1219	1607	1651	2235
AA 300 ANSI	279	368	473	568	695	800	908	930	1108	1260	1263	1619	1702	2302
B Diameter	168	232	292	400	508	600	698	711	900	900	900	1351	1422	1676
C Maximum	178	219	295	381	454	533	530	654	635	800	800	1116	1391	1499
D 150 ANSI	—	176	226	272	324	380	—	—	532	535	—	—	—	—
DD 300 ANSI	—	184	238	284	—	—	—	—	—	—	—	—	—	—
E 150 ANSI	—	140	171	184	205	349	—	—	402	405	—	—	—	—
EE 300 ANSI	—	148	184	197	—	—	—	—	—	—	—	—	—	—
F 150 ANSI	95	114	140	171	203	241	279	289	403	370	432	505	648	864
FF 300 ANSI	105	127	159	191	222	260	292	324	403	408	483	559	699	978
H NPT Body Tapping	0.375	0.50	0.75	0.75	1.00	1.00	1.00	1.00	1.00	1.00	1.00	1.00	2.00	2.00
J NPT Cover Center Plug	0.50	0.50	0.75	0.75	1.00	1.00	1.25	1.25	2.00	2.00	2.00	1.00	2.00	2.00
K NPT Cover Tapping	0.375	0.50	0.75	0.75	1.00	1.00	1.00	1.00	1.00	1.00	1.00	1.00	2.00	2.00
Stem Travel	15	20	28	43	58	71	86	86	114	114	114	165	191	216
Approx. Ship Weight (kgs)	20	39	89	150	284	409	568	627	681	1157	1249	2951	3876	5942
Approx. X Pilot System	331	381	686	762	839	915	915	1042	1016	1169	1397	1728	2007	2185
Approx. Y Pilot System	254	280	458	508	559	610	661	661	762	762	762	991	1016	1194
Approx. Z Pilot System	254	280	458	508	559	610	661	661	762	762	762	991	1067	1245

*Consult Factory

631-22 Valve Selection	100-20 Pattern: Globe (G), Angle (A), End Connections: Flanged (F) Indicate Available Sizes															
	Inches	3	4	6	8	10	12	14	16	18	20	24	30	36	42	48
	mm	80	100	150	200	250	300	350	400	450	500	600	750	900	1000	1200
Main Valve 100-20	Pattern	G	G, A	G, A	G, A	G	G	G	G	G	G	G	G	G	G	G
	End Detail	F	F	F	F	F	F	F	F	F	F	F	F	F	F	F
Suggested Flow (gpm)	Maximum	260	580	1025	2300	4100	6400	9230	9230	16500	16500	16500	28000	42000	57000	57000
	Minimum	1	2	4	10	15	35	50	50	95	95	95	275	450	450	450
Suggested Flow (Liters/Sec)	Maximum	16	37	65	145	258	403	581	581	1040	1040	1040	1764	2115	2115	2115
	Minimum	.06	.13	.25	.63	.95	2.2	3.2	3.2	6.0	6.0	6.0	17.4	28.4	41.0	41.0

100-20 Series is the reduced internal port size version of the 100-01 Series.

For Lower Flows Consult Factory

631-22 Pilot System Specifications

Temperature Range

Water: to s

Rubber Parts:

Buna-N® Rubber Synthetic

Solenoid Control

Body:

Brass ASTM B283

Enclosure:

NEMA Type 1,2,3,3S,4,4X general purpose watertight*
NEMA Type 6,6P,7,9 Watertight Explosion-Proof available.

Please consult factory
for pilot system
adjustment ranges

Voltages:

110, 220, -50Hz Ac

24, 120, 240, 480 - 60Hz AC

6, 12, 24, 120, 240 - DC

Others available at extra cost

Max. operating pressure differential: 200 psi unless otherwise specified

Coil:

Insulation molded Class	F
Watts AC	6
AC Volt Amps Inrush	30
AC Volt Amps Holding	16
Watts DC	10.6

When Ordering, Specify:

1. Catalog No. 631-22
2. Valve Size
3. Pattern - Globe or Angle
4. Pressure Class
5. Threaded, Flanged or Grooved
6. Trim Material
7. Adjustment Range
8. Desired Options
9. When Vertically Installed

631-22 Flow Data

