



MODEL

52-03

Pressure Relief & Surge Anticipator Valve



- Protects Against Water Hammer Surges
- Opens on Initial Low Pressure Wave
- Closes Slowly to Prevent Subsequent Surges
- Adjustable Over a Wide Range of Settings

The Cla-Val Model 52-03 Surge Anticipator Valve is indispensable for protecting pumps, pumping equipment and all applicable pipelines from dangerous pressure surges caused by rapid changes of flow velocity within a pipeline.

When pumping systems are started and stopped gradually, harmful surges do not occur. Should a power failure take place, however the abrupt stopping of the pump can cause dangerous surges in the system which could result in severe equipment damage.

Power failure to a pump will usually result in a down surge in pressure, followed by an up surge in pressure. The surge control valve opens on the initial low pressure surge wave, diverting the returning high pressure wave from the system.*In effect, the valve has anticipated the returning high pressure wave and is open to dissipate the damage causing surge. The valve will then close slowly without generating any further pressure surges.

* An adjustable hydraulic flow control limits the valve opening for a controlled initial surge relief.

Schematic Diagram

Item	Description
1	100-01 Hytrol Main Valve
2	X102F Flow Limiter
3	X101 Valve Position Indicator *
4	CK2 Isolation Valve
5	100-01 Hytrol (Reverse Flow)
6	CRL-60 Pressure Relief Control
7	CRA Pressure Reducing Control
8	X58B Restriction Tube Assembly
9	CSC Swing Check Valve
10	X42N-3 Strainer Needle Valve
11	Bell Reducer
12	Pressure Gage
13	CK2 Isolation Valve
14	CK2 Isolation Valve

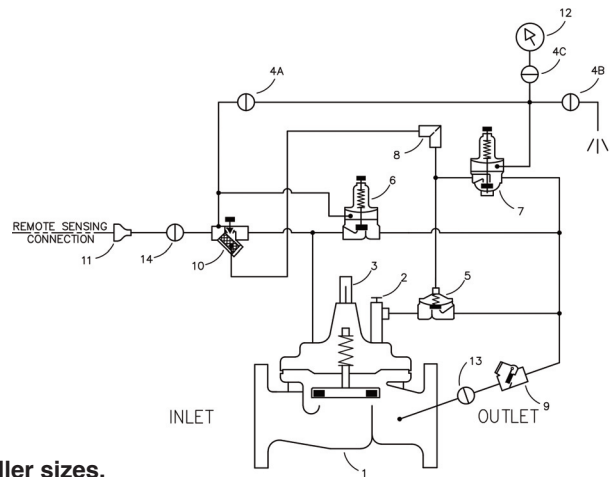

*Note: X101 or X105L Accessories not available in 4" and smaller sizes.

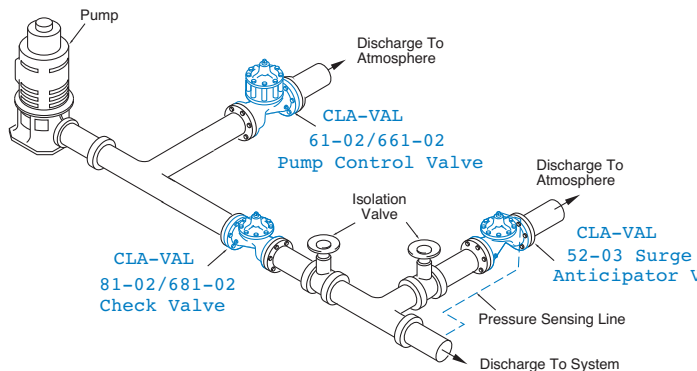

Typical Application

The Model 52-03 discharges to atmosphere from a tee in the pump discharge header. The valve anticipates surges caused by power failure as well as acting as a standard overpressure relief valve.

Notes:

- The remote pressure sensing line should be 3/4" minimum I.D. installed from the valve to the pipeline to avoid air pockets.
- We recommend protecting valve and tubing from freezing temperatures.

Model 52-03 (Uses 100-01 Hytrol Main Valve)

Pressure Ratings (Recommended Maximum Pressure - psi)

Valve Body & Cover		Pressure Class				
		Flanged		Grooved	Threaded	
Grade	Material	ANSI Standards*	150 Class	300 Class	300 Class	End‡ Details
ASTM A536	Ductile Iron	B16.42	250	400	400	400
ASTM A216-WCB	Cast Steel	B16.5	285	400	400	400
UNS 87850	Bronze	B16.24	225	400	400	400

Note: * ANSI standards are for flange dimensions only.
 Flanged valves are available faced but not drilled.
 ‡ End Details machined to ANSI B2.1 specifications.
Valves for higher pressure are available; consult factory for details

Materials

Component	Standard Material Combinations		
Body & Cover	Ductile Iron	Cast Steel	Bronze
Available Sizes	2-1/2" - 18"	2-1/2" - 16"	2-1/2" - 16"
	65 - 450 mm	65 - 400 mm	65 - 400 mm
Disc Retainer & Diaphragm Washer	Cast Iron	Cast Steel	Bronze
Trim: Disc Guide, Seat & Cover Bearing	Bronze is Standard Stainless Steel is Optional		
Disc	Buna-N® Rubber		
Diaphragm	Nylon Reinforced Buna-N® Rubber		
Stem, Nut & Spring	Stainless Steel		

For material options not listed, consult factory.
 Cla-Val manufactures valves in more than 50 different alloys.

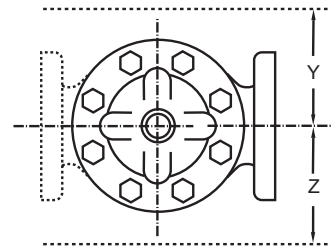
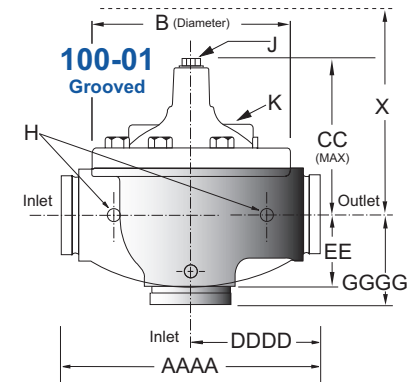
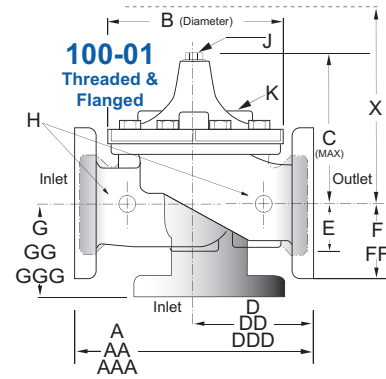

Model 52-03 Dimensions (In Inches)

Valve Size (Inches)	2½	3	4	6	8	10	12	14	16	18
A Threaded	11.00	12.50	—	—	—	—	—	—	—	—
AA 150 ANSI	11.00	12.00	15.00	20.00	25.38	29.75	34.00	39.00	41.38	46.00
AAA 300 ANSI	11.62	13.25	15.62	21.00	26.38	31.12	35.50	40.50	43.50	47.64
AAAA Grooved End	11.00	12.50	15.00	20.00	25.38	—	—	—	—	—
B Diameter	8.00	9.12	11.50	15.75	20.00	23.62	28.00	32.75	35.50	41.50
C Maximum	7.56	8.19	10.62	13.38	16.00	17.12	20.88	24.19	25.00	39.06
CC Maximum Grooved End	6.88	7.25	9.31	12.12	14.62	—	—	—	—	—
D Threaded	5.50	6.25	—	—	—	—	—	—	—	—
DD 150 ANSI	5.50	6.00	7.50	10.00	12.69	14.88	17.00	19.50	20.81	—
DDD 300 ANSI	5.88	6.38	7.88	10.50	13.25	15.56	17.75	20.25	21.62	—
DDDD Grooved End	—	6.00	7.50	—	—	—	—	—	—	—
E	1.69	2.06	3.19	4.31	5.31	9.25	10.75	12.62	15.50	12.95
EE Grooved End	2.88	3.12	4.25	6.00	7.56	—	—	—	—	—
F 150 ANSI	3.50	3.75	4.50	5.50	6.75	8.00	9.50	10.50	11.75	15.00
FF 300 ANSI	3.75	4.13	5.00	6.25	7.50	8.75	10.25	11.50	12.75	15.00
G Threaded	4.00	4.50	—	—	—	—	—	—	—	—
GG 150 ANSI	4.00	4.00	5.00	6.00	8.00	8.62	13.75	14.88	15.69	—
GGG 300 ANSI	4.31	4.38	5.31	6.50	8.50	9.31	14.50	15.62	16.50	—
GGGG Grooved End	—	4.25	5.00	—	—	—	—	—	—	—
H NPT Body Tapping	0.50	0.50	0.75	0.75	1.00	1.00	1.00	1.00	1.00	1.00
J NPT Cover Center Plug	0.50	0.50	0.75	0.75	1.00	1.00	1.25	1.50	2.00	1.00
K NPT Cover Tapping	0.50	0.50	0.75	0.75	1.00	1.00	1.00	1.00	1.00	1.00
Stem Travel	0.70	0.80	1.10	1.70	2.30	2.80	3.40	4.00	4.50	5.10
Approx. Ship Weight (lbs)	50	70	140	285	500	780	1165	1600	2265	2982
Approx. X Pilot System	14	15	17	29	31	33	36	40	40	43
Approx. Y Pilot System	10	11	12	20	22	24	26	29	30	32
Approx. Z Pilot System	10	11	12	20	22	24	26	29	30	32

Model 52-03 Metric Dimensions (Uses 100-01 Hytrol Main Valve)

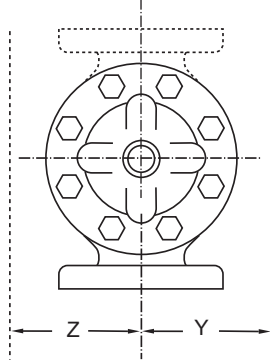
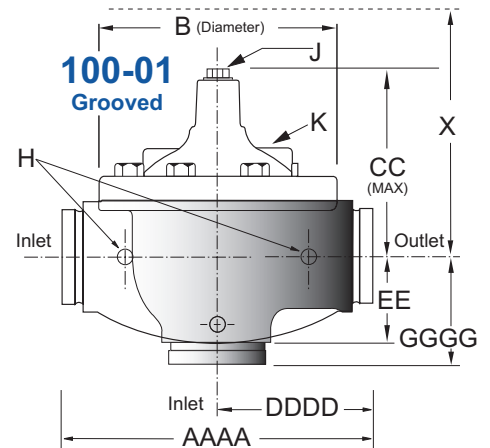
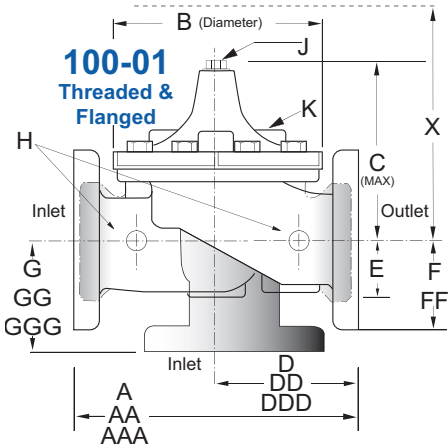

Model 100-01 Full Port Hytrol Main Valve

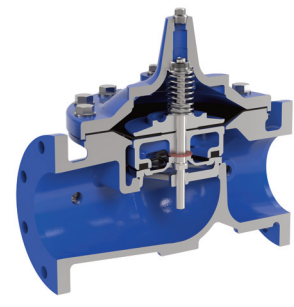

Model 52-03 Dimensions (In mm)

Valve Size (mm)	65	80	100	150	200	250	300	350	400	450
A Threaded	279	318	—	—	—	—	—	—	—	—
AA 150 ANSI	279	305	381	508	645	756	864	991	1051	1168
AAA 300 ANSI	295	337	397	533	670	790	902	1029	1105	1210
AAAA Grooved End	279	318	381	508	645	—	—	—	—	—
B Diameter	203	232	292	400	508	600	711	832	902	1054
C Maximum	192	208	270	340	406	435	530	614	635	992
CC Maximum Grooved End	175	184	236	308	371	—	—	—	—	—
D Threaded	140	159	—	—	—	—	—	—	—	—
DD 150 ANSI	140	152	191	254	322	378	432	495	528	—
DDD 300 ANSI	149	162	200	267	337	395	451	514	549	—
DDDD Grooved End	—	152	191	—	—	—	—	—	—	—
E	43	52	81	110	135	235	273	321	394	329
EE Grooved End	73	79	108	152	192	—	—	—	—	—
F 150 ANSI	89	95	114	140	171	203	241	267	298	381
FF 300 ANSI	95	105	127	159	191	222	260	292	324	381
G Threaded	102	114	—	—	—	—	—	—	—	—
GG 150 ANSI	102	102	127	152	203	219	349	378	399	—
GGG 300 ANSI	110	111	135	165	216	236	368	397	419	—
GGGG Grooved End	—	108	127	—	—	—	—	—	—	—
H NPT Body Tapping	0.50	0.50	0.75	0.75	1.00	1.00	1.00	1.00	1.00	1.00
J NPT Cover Center Plug	0.50	0.50	0.75	0.75	1.00	1.00	1.25	1.50	2.00	1.00
K NPT Cover Tapping	0.50	0.50	0.75	0.75	1.00	1.00	1.00	1.00	1.00	1.00
Stem Travel	18	20	28	43	58	71	86	102	114	130
Approx. Ship Weight (kgs)	23	32	64	129	227	354	528	726	1027	1353
Approx. X Pilot System	356	381	432	737	788	839	915	1016	1016	1093
Approx. Y Pilot System	254	280	305	508	559	610	661	737	762	813
Approx. Z Pilot System	254	280	305	508	559	610	661	737	762	813

52-03 Valve Selection	100-01 Pattern: Globe (G), Angle (A), End Connections: Threaded (T), Grooved (GR), Flanged (F) Indicate Available Sizes										
	Inches	2½	3	4	6	8	10	12	14	16	18
	mm	65	80	100	150	200	250	300	350	400	450
Basic Valve 100-01	Pattern	G, A	G, A	G, A	G, A	G, A	G, A	G, A	G, A	G, A	G
	End Detail	T, F, Gr*	T, F, Gr	F, Gr	F, Gr*	F, Gr*	F	F	F	F	F
Suggested Flow (gpm)	Maximum	300	460	800	1800	3100	4900	7000	8400	11000	14000
	Maximum Surge	670	1000	1800	4000	7000	11000	16000	19000	25000	31000
Suggested Flow (Liters/Sec)	Maximum	19	29	50	113	195	309	442	530	694	883
	Maximum Surge	42	63	113	252	441	693	1008	1197	1577	1956

100-01 Series is the full internal port Hytrol. *Globe Grooved Only

Sizing Information: Because of the many variable conditions that generally exist in any given system, proper sizing is important. Incorrect valve sizing will nullify the ability of the Surge Anticipator Valve. For valve sizing assistance, contact Cla-Val with the following specific pump and system information: number and type of pumps; shutoff head; flow rate; discharge static head and pumping head; pipe size; length; thickness and material.



CRL-60 Pilot Control
Direct-acting, spring loaded, diaphragm type relief pilot capable of opening and closing within very close pressure limits.



CRA Pilot Control
Automatically reduces a higher inlet pressure to a lower outlet pressure. Direct acting, spring loaded, diaphragm type - hydraulic or pneumatic operation.

Adjustment Ranges

High Pressure Pilot (CRL-60)

- 0 to 75 psi
- 20 to 200 psi *
- 100 to 300 psi
- 250 to 600 psi

Low Pressure Pilot (CRA)

- 2 to 30 psi
- 15 to 75 psi
- 30 to 300 psi *

*Supplied unless otherwise specified
Other ranges available, please consult factory

Temperature Range

Water: to 180°F

Materials

Standard Pilot System Materials

- Pilot Control: Low Lead Bronze
- Trim: Stainless Steel 303
- Rubber: Buna-N® Synthetic Rubber

Optional Pilot System Materials

Pilot systems are available with optional Aluminum, Stainless Steel or Monel materials.

When Ordering, Specify:

1. Catalog No. 52-03
2. Valve Size
3. Pattern - Globe or Angle
4. Pressure Class
5. Threaded or Flanged
6. Trim Material
7. Adjustment Range
8. Desired Options
9. When Vertically Installed

Valve Options



X141 Pressure Gauge



X101AR Valve Position Indicator with Air Release



X101 Valve Position Indicator



X144 e-FlowMeter



X43H Strainer



Stainless Steel Pilot