



—MODEL— **100-01**

Hytrol Valve



- Drip-Tight, Positive Seating
- Service Without Removal From Line
- Threaded, Flanged or Grooved Ends
- Globe or Angle Pattern
- 100% Factory Tested

The Cla-Val Model 100-01 Hytrol Valve is a hydraulically operated, diaphragm actuated, globe or angle pattern valve. It consists of three major components: body, diaphragm assembly, and cover. The diaphragm assembly is the only moving part.

The diaphragm assembly is guided top and bottom by a precision machined stem. It utilizes a non-wicking diaphragm of nylon fabric bonded with synthetic rubber. A resilient synthetic rubber disc retained on three and one half sides by a disc retainer forms a drip-tight seal with the renewable seat when pressure is applied above the diaphragm.

The Model 100-01 is the basic valve used in nearly all Cla-Val Automatic Control Valves. It is the valve of choice for system applications requiring remote control, pressure regulation, solenoid operation, rate of flow control, liquid level control or check valve operation. The rugged simplicity of design and packless construction assure a long life of dependable, trouble-free operation. It is available in various materials and in a full range of sizes, with either threaded, flanged or grooved ends. Its applications are unlimited.

Principle of Operation

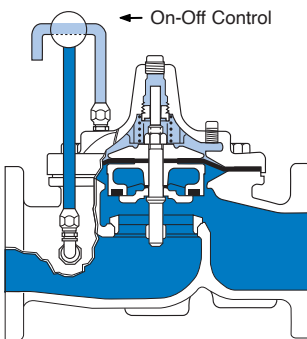

Full Open Operation

When pressure in the cover chamber is relieved to a zone of lower pressure, the line pressure at the valve inlet opens the valve, allowing full flow.

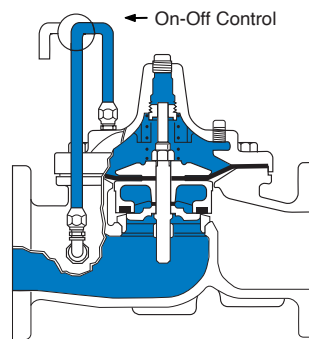

Tight Closing Operation

When pressure from the valve inlet is applied to the cover chamber, the valve closes drip-tight.

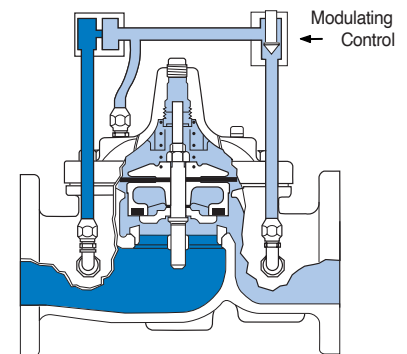

Modulating Action

The valve holds any intermediate position when operating pressures are equal above and below the diaphragm. A Cla-Val "Modulating" Pilot Control will allow the valve to automatically compensate for line pressure changes.

Specifications

Available Sizes

Pattern	Threaded	Flanged	Grooved End
Globe	10 - 80 mm	40 - 900 mm	40 - 50 - 65 - 80 - 100 150 - 200 mm
Angle	25 - 80 mm	40 - 400 & 600 mm	40 - 50 - 65 - 80 100 - 150 mm

Pressure Ratings (Recommended Maximum Pressure - psi)

Valve Body & Cover		Pressure Class				
		Flanged		Grooved	Threaded	
Grade	Material	ANSI Standards*	150 Class	300 Class	300 Class	End‡ Details
ASTM A536	Ductile Iron	B16.42	250	400	400	400
ASTM A216-WCB	Cast Steel	B16.5	285	400	400	400
UNS 87850	Bronze	B16.24	225	400	400	400

Note: * ANSI standards are for flange dimensions only.
Flanged valves are available faced but not drilled.
‡ End Details machined to ANSI B2.1 specifications.

Valves for higher pressure are available; consult factory for details

Materials

Component	Standard Material Combinations		
Body & Cover	Ductile Iron	Cast Steel	Bronze
Available Sizes	10 - 900 mm	25 - 400 mm	25 - 400 mm
Disc Retainer & Diaphragm Washer	Cast Iron	Cast Steel	Bronze
Trim: Disc Guide, Seat & Cover Bearing	Bronze is Standard Stainless Steel is optional		
Disc	Buna-N® Rubber		
Diaphragm	Nylon Reinforced Buna-N® Rubber		
Stem, Nut & Spring	Stainless Steel		
For material options not listed, consult factory. Cla-Val manufactures valves in more than 50 different alloys.			

Viton® Rubber Parts - suffix KB

Optional diaphragm, disc and o-ring fabricated with Viton® synthetic rubber. Viton® is well suited for use with mineral acids, salt solutions, chlorinated hydrocarbons, and petroleum oils; and is primarily used in high temperature applications up to 120° C. Do not use with epoxy coatings above 80° C.

Epoxy Coating - suffix KC

The NSF/ANSI 61 fusion bonded epoxy coating option is for use with cast iron, ductile iron or steel valves. This coating is resistant to various water conditions, certain acids, chemicals, solvents and alkalis. epoxy coatings are applied in accordance with AWWA coating specifications C116-03.

Do not use with temperatures above 80° C.

Dura-Kleen® Stem - suffix KD

This stem is designed for applications where water supplies containing dissolved minerals create deposits that build-up on a standard stem and hamper valve operation. A patented, self-cleaning design on the stem allows all valve sizes to operate freely in the harshest conditions.

Delrin® Sleeved Stem - suffix KG

The Delrin® sleeved stem is designed for applications where water supplies contain dissolved minerals which can form deposits that build up on the valve stem and hamper valve operation. Scale build-up will not adhere to the Delrin® sleeve stem. Delrin® sleeved stems are not recommended for valves in continuous operation where differential pressures are in excess of 80 psi (50 mm and larger Hytrol valves).

Model 100-01

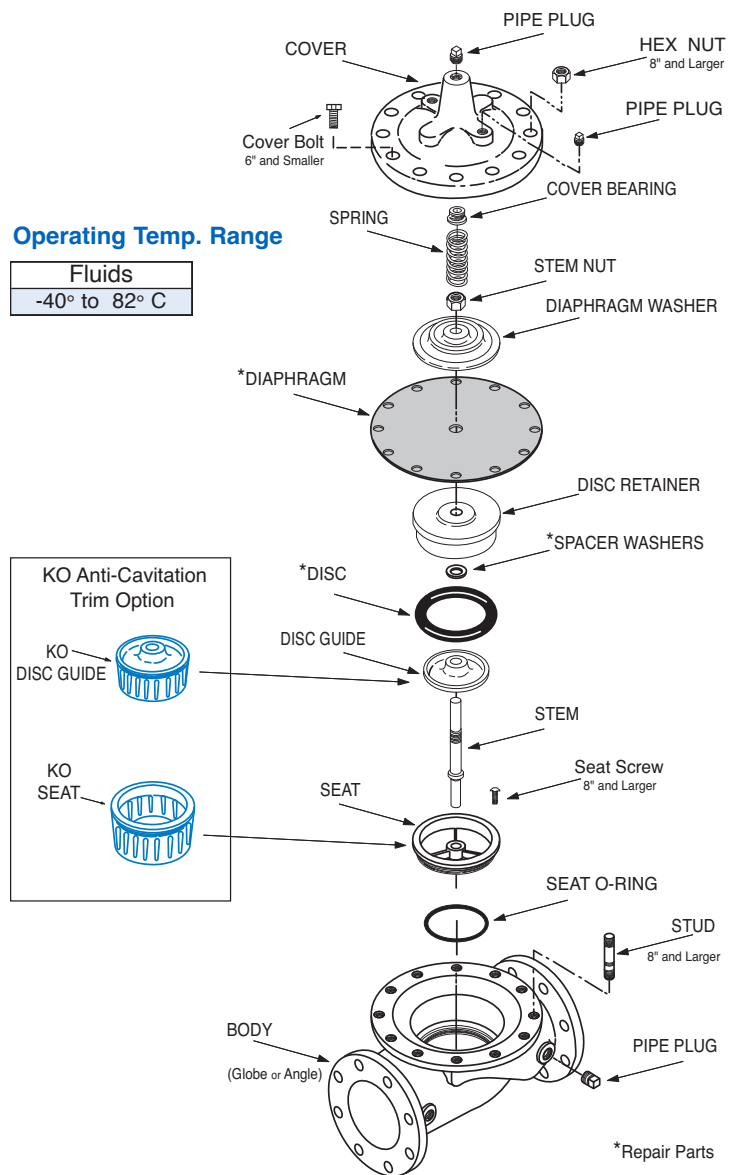

Operating Temp. Range

Fluids
-40° to 82° C

For assistance in selecting appropriate valve options or valves manufactured with special design requirements, please contact our Regional Sales Office or Factory.

Functional Data

Model 100-01

† Non Guided Stem

Valve Size		Inches	10	15	20	25	25	32	40	50	65	80	100	150	200	250	300	350	400	450	500	600	750	900
		mm.	10	15	20	25	32	40	50	65	80	100	150	200	250	300	350	400	450	500	600	750	900	
C _V Factor	Globe Pattern	Gal./Min.(gpm.)	1.8	6	8.5	13.3	20	30	32	54	85	115	200	440	770	1245	1725	2300	3130	4463	5345	7655	10150	14020
		Litres/Sec. (l/s.)	.11	.38	.54	.84	1.26	1.89	2	3.4	5.4	7.3	13	28	49	79	109	145	198	282	337	483	640	885
Equivalent Length of Pipe	Globe Pattern	Feet (ft.)	25	7	16	23	10	19	37	51	53	85	116	211	291	347	467	422	503	612	595	628	1181	2285
		Meters (m.)	7.6	2.2	4.8	7.1	3.1	5.7	12	15.5	16	26	35	64	89	106	142	129	154	187	181	192	360	696
K Factor	Globe Pattern	Feet (ft.)	—	—	—	—	9.0	28	46	40	37	58	80	139	176	217	222*	238*	247*	—	—	372*	—	—
		Meters (m.)	—	—	—	—	2.8	8.7	14	12	11	18	25	43	54	66	68	73	75	—	—	113	—	—
Liquid Displaced from Cover Chamber When Valve Opens	Globe Pattern	Fl. Oz	.12	.34	.34	.70	—	—	—	—	—	—	—	—	—	—	—	—	—	—	—	—	—	—
		U.S. Gal.	—	—	—	—	.02	.02	.02	.03	.04	.08	.17	.53	1.26	2.51	4.0	6.5	9.6	11	12	29	42	90
K Factor	Angle Pattern	Feet (ft.)	—	—	—	—	2.5	4.4	7.1	4.4	3.3	4.1	4.1	4.1	3.7	3.6	2.9	2.8	2.6	—	—	2.4	—	—
		Meters (m.)	—	—	—	—	0.76	1.34	2.16	1.34	1.01	1.26	1.26	1.26	1.13	1.10	0.89	0.86	0.79	—	—	0.73	—	—
K Factor	Globe Pattern	Fl. Oz	16.3	3.7	5.7	6.1	2.7	3.6	5.9	5.6	4.6	6.0	5.9	6.2	6.1	5.8	6.1	5.0	4.6	5.2	3.9	4.0	6.4	6.4
		U.S. Gal.	—	—	—	—	2.5	4.4	7.1	4.4	3.3	4.1	4.1	4.1	3.7	3.6	2.9	2.8	2.6	—	—	2.4	—	—
K Factor	Angle Pattern	Fl. Oz	—	—	—	—	—	—	—	—	—	—	—	—	—	—	—	—	—	—	—	—	—	—
		U.S. Gal.	—	—	—	—	—	—	—	—	—	—	—	—	—	—	—	—	—	—	—	—	—	—
K Factor	Globe Pattern	ml	3.5	10.1	10.1	20.7	75.7	75.7	75.7	121	163	303	643	—	—	—	—	—	—	—	—	—	—	—
		Litres	—	—	—	—	—	—	—	—	—	—	—	2.0	4.8	9.5	15.1	24.6	36.2	41.6	45.4	109.8	159	340

*Estimated

C_V Factor

Formulas for computing C_V Factor, Flow (Q) and Pressure Drop (ΔP):

$$C_V = \frac{Q}{\sqrt{\Delta P}} \quad Q = C_V \sqrt{\Delta P} \quad \Delta P = \left(\frac{Q}{C_V}\right)^2$$

K Factor (Resistance Coefficient)

The Value of K is calculated from the formula: $K = \frac{894d^4}{C_V^2}$ (U.S. system units)

Equivalent Length of Pipe

Equivalent lengths of pipe (L) are determined from the formula: $L = \frac{Kd}{12f}$ (U.S. system units)

Fluid Velocity

Fluid velocity can be calculated from the following formula: $V = \frac{.4085 Q}{d^2}$ (U.S. system units)

Where:

C_V = U.S. (gpm) @ 1 psi differential at 60° F water
or

C_V-l/s = (l/s) @ 1 bar (14.5 PSIG) differential at 15° C water

d = inside pipe diameter of Schedule 40 Steel Pipe (inches)

f = friction factor for clean, new Schedule 40 pipe (dimensionless) (from Cameron Hydraulic Data, 18th Edition, P 3-119)

K = Resistance Coefficient (calculated)

L = Equivalent Length of Pipe (feet)

Q = Flow Rate in U.S. (gpm) or (l/s)

V = Fluid Velocity (feet per second) or (meters per second)

ΔP = Pressure Drop in (psi) or (bar)

Model 100-01 Flow Chart (Based on normal flow through a wide open valve)

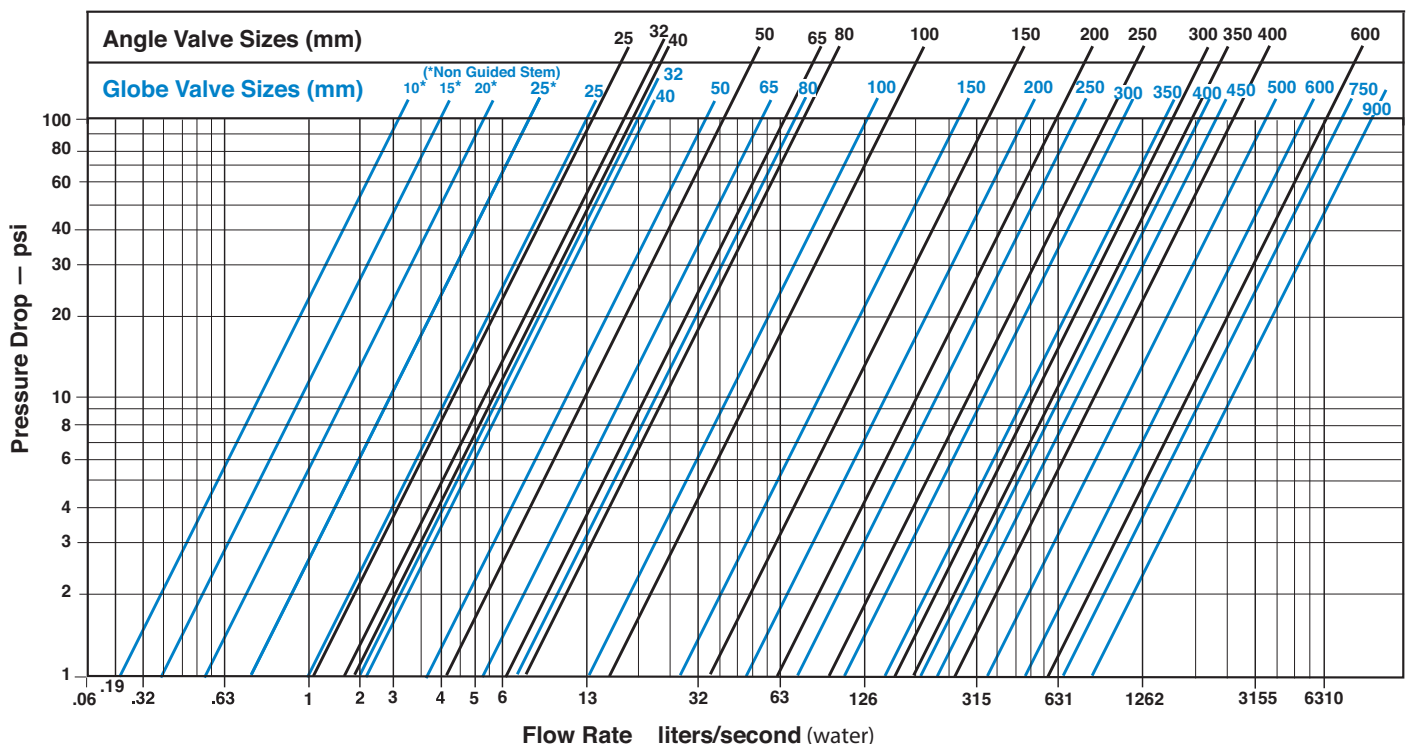

Dimensions

100-01 10mm, 15mm, 20mm, 25mm Auxillary Hytrol Valves with non Guided Stems

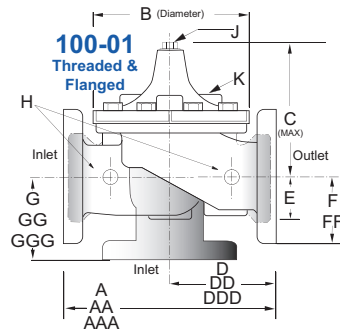
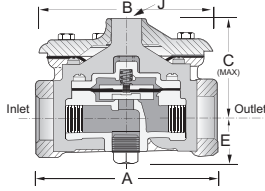

Model 100-01

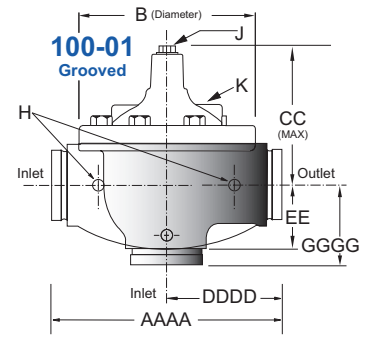
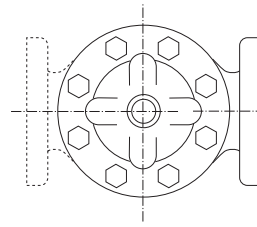

Valve Size (mm)	10*	15*	20*	25*	25	32	40	50	65	80	100	150	200	250	300	350	400	450†	500†	600†	750†	900†
A Threaded	70	89	89	130	184	184	184	238	279	318	—	—	—	—	—	—	—	—	—	—	—	—
AA 150 ANSI	—	—	—	—	—	—	216	238	279	305	381	508	645	756	864	991	1051	1168	1321	1562	1600	1848
AAA 300 ANSI	—	—	—	—	—	—	229	254	295	337	397	533	670	790	902	1029	1105	1210	1326	1606	1638	1899
AAAA Grooved End	—	—	—	—	—	—	216	228	279	318	381	508	645	—	—	—	—	—	—	—	—	—
B Diameter	64	80	80	111	143	143	143	168	203	232	292	400	508	600	711	832	902	1054	1143	1350	1422	1676
C Maximum	59	149	149	159	140	140	140	165	192	208	270	340	406	435	530	614	635	992	1074	1143	1390	1499
CC Maximum Grooved End	—	—	—	—	—	—	120	146	175	184	236	308	371	—	—	—	—	—	—	—	—	—
D Threaded	—	—	—	—	83	83	83	121	140	159	—	—	—	—	—	—	—	—	—	—	—	—
DD 150 ANSI	—	—	—	—	—	—	102	121	140	152	191	254	322	378	432	495	528	—	—	781	—	—
DDD 300 ANSI	—	—	—	—	—	—	108	127	149	162	200	267	337	395	451	514	549	—	—	803	—	—
DDDD Grooved End	—	—	—	—	—	—	121	—	152	191	—	—	—	—	—	—	—	—	—	—	—	—
E Bottom of Valve	32	18	18	22	29	29	29	38	43	52	81	110	135	235	273	321	394	329	381	451	541	624
EE Grooved End	—	—	—	—	—	—	52	64	73	79	108	152	192	—	—	—	—	—	—	—	—	—
F 150 ANSI	—	—	—	—	—	—	64	76	89	95	114	140	171	203	273	321	394	381	419	489	572	724
FF 300 ANSI	—	—	—	—	—	—	78	83	95	105	127	159	191	222	260	292	324	381	419	489	610	762
G Threaded	—	—	—	—	48	48	48	83	102	114	—	—	—	—	—	—	—	—	—	—	—	—
GG 150 ANSI	—	—	—	—	—	—	102	83	102	102	127	152	203	219	349	378	399	—	—	560	—	—
GGG 300 ANSI	—	—	—	—	—	—	102	89	110	111	135	165	216	236	368	397	419	—	—	582	—	—
GGGG Grooved End	—	—	—	—	—	—	83	—	108	127	—	—	—	—	—	—	—	—	—	—	—	—
H NPT Body Tapping	—	0.125	0.125	0.25	0.375	0.375	0.375	0.375	0.50	0.50	0.75	0.75	1.00	1.00	1.00	1.00	1.00	1.00	1.00	1.00	2.00	2.00
J NPT Cover Center Plug	0.125	0.125	0.125	0.25	0.25	0.25	0.25	0.50	0.50	0.50	0.75	0.75	1.00	1.00	1.25	1.50	2.00	1.00	1.00	1.00	2.00	2.00
K NPT Cover Tapping	—	0.125	0.125	0.25	0.375	0.375	0.375	0.375	0.50	0.50	0.75	0.75	1.00	1.00	1.00	1.00	1.00	1.00	1.00	1.00	2.00	2.00
Stem Travel	—	—	—	—	10	10	10	15	18	20	28	43	58	71	86	102	114	130	143	171	190	216
Approx. Ship Weight (kgs)	1.4	1.4	1.4	6	7	7	7	16	23	32	64	129	227	354	528	726	1027	1353	1769	2812	3494	5316

Note: The top two flange holes on valve size 900mm are threaded to 1 1/2"-6 UNC.

*Non Guided Stem Auxiliary Hytrol Controls

†450mm and larger 100-01 series Hytrol valves are equipped with flange feet for safety and convenience. Consult Cla-Val representative for details.

Cla-Val Control Valves operate with maximum efficiency when mounted in horizontal piping with the main valve cover UP, however, other positions are acceptable. Due to component size and weight of 8 inch and larger valves, installation with cover UP is advisable. We recommend isolation valves be installed on inlet and outlet for maintenance. Adequate space above and around the valve for service personnel should be considered essential. A regular maintenance program should be established based on the specific application data. However, we recommend a thorough inspection be done at least once a year. Consult factory for specific recommendations.

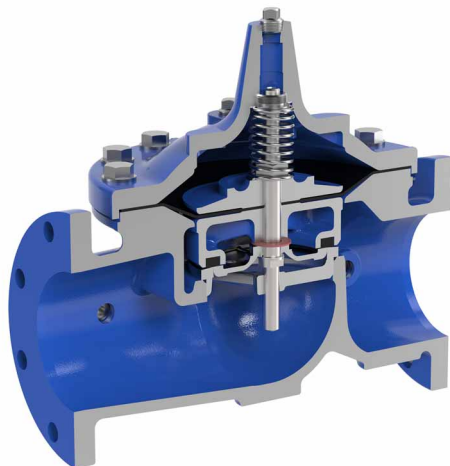

go to www.cla-val.com and click on the YouTube link to view a 3D animation demonstrating how the 100-01 operates