



— MODEL — **660-73**

# Booster Pump Control Valve



- Simple Hydraulic Operation
- Low Head Loss
- Horizontal or Vertical Mounting
- Built-in Check Valve
- Proven Reliable Design

The Cla-Val Model 660-73 Booster Pump Control Valve is a pilot-operated valve designed for installation on the discharge of booster pumps to eliminate pipeline surges caused by the starting and stopping of the pump.

The pump starts against a closed valve. When the pump is started, the solenoid control is energized and the valve begins to open slowly, gradually increasing line pressure to full pumping head. When the pump is signaled to shut-off, the solenoid control is de-energized and the valve begins to close slowly, gradually reducing flow while the pump continues to run. When the valve is closed, a limit switch assembly, which serves as an electrical interlock between the valve and the pump, releases the pump starter and the pump stops.

Should a power failure occur, a built-in lift-type check valve closes the moment flow stops, preventing reverse flow regardless of solenoid or diaphragm assembly position.

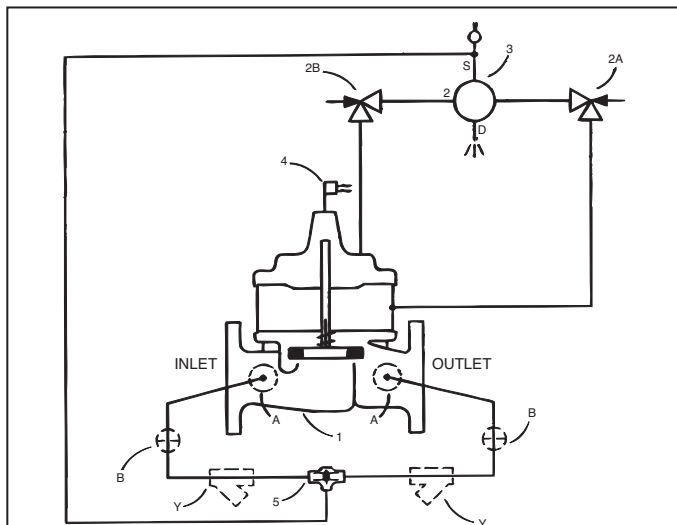

## Schematic Diagram

Item	Description
1	Powercheck Main Valve 100-31
2	CV Flow Control
3	CSM11-A2-2 Solenoid Control
4	X105LCW Switch Assembly
5	CVS-1 Shuttle Valve

## Optional Features

Item	Description
A	X46A Flow Clean Strainer
B	CK2 Isolation Valve
Y	X43 "Y" Strainer

## Typical Installation

Install Model 660-73 valve as shown. Flexible conduit should be used for electrical connections to the solenoid control and the limit switch. The Model 52-02 or 652-03 Surge Anticipator Valve is recommended for power failure protection.

### Note:

Valve stem can be located in either vertical up or horizontal position.

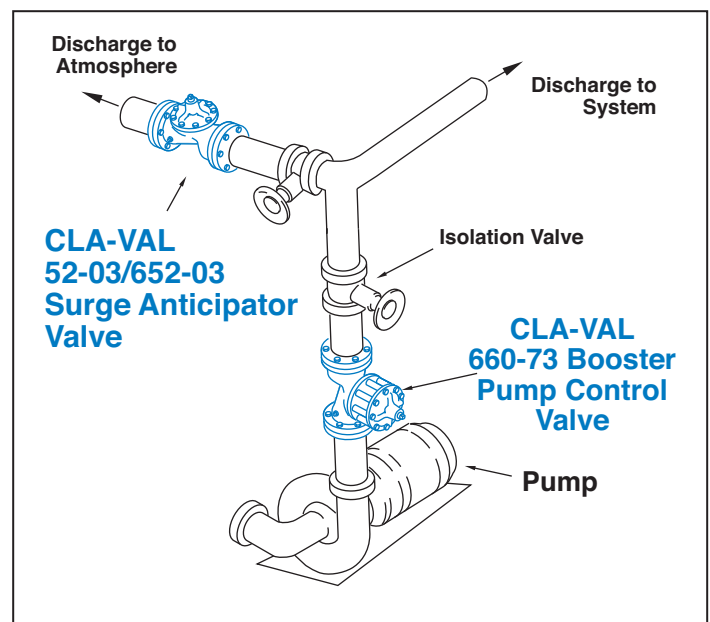

## Pressure Ratings (Recommended Maximum Pressure - psi)

Valve Body & Cover		Pressure Class			
		Flanged			Threaded
Grade	Material	ANSI Standards*	150 Class	300 Class	End‡ Details
ASTM A536	Ductile Iron	B16.42	250	400	400
ASTM A216-WCB	Cast Steel	B16.5	285	400	400
UNS 87850	Bronze	B16.24	225	400	400

Note: \* ANSI standards are for flange dimensions only.  
 Flanged valves are available faced but not drilled.  
 ‡ End Details machined to ANSI B2.1 specifications.  
**Valves for higher pressure are available; consult factory for details**

## Materials

Component	Standard Material Combinations		
Body & Cover	Ductile Iron	Cast Steel	Bronze
100-31 Sizes (inches)	4" - 10"	4" - 10"	4" - 10"
Disc Retainer & Diaphragm Washer	Cast Iron	Cast Steel	Bronze
Trim: Disc Guide, Seat & Cover Bearing	Bronze is Standard Stainless Steel is Optional		
Disc	Buna-N® Rubber		
Diaphragm	Nylon Reinforced Buna-N® Rubber		
Stem, Nut & Spring	Stainless Steel		

For material options not listed, consult factory.  
 Cla-Val manufactures valves in more than 50 different alloys.

## Dimensional Data

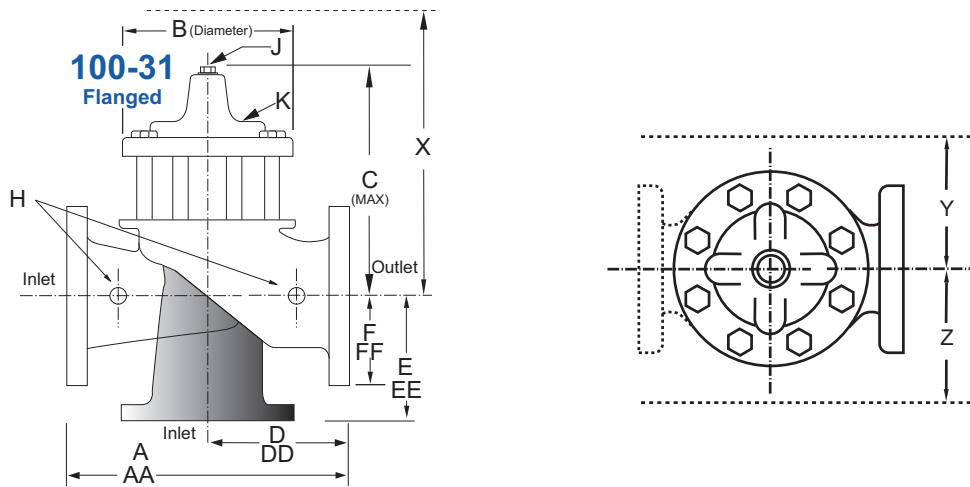

## 660-73 Series Dimensions (Reduced Internal Port 100-31) (inches)

Valve Size (Inches)	4	6	8	10
A 150 ANSI	13.88	17.75	21.38	26.00
AA 300 ANSI	14.50	18.62	22.38	27.38
B Diameter	9.12	11.50	15.75	20.00
C Maximum	8.62	15.25	20.25	23.75
D 150 ANSI	6.94	8.88	10.69	—
DD 300 ANSI	7.25	9.38	11.19	—
E 150 ANSI	5.50	6.75	7.25	—
EE 300 ANSI	5.81	7.25	7.75	—
F 150 ANSI	4.50	5.50	6.75	8.00
FF 300 ANSI	5.00	6.25	7.50	8.75
H NPT Body Tapping	0.50	0.75	0.75	1.00
J NPT Cover Center Plug	0.50	0.75	0.75	1.00
K NPT Cover Tapping	0.50	0.75	1.00	1.00
Stem Travel	0.60	0.80	1.70	2.30
Approx. Ship Weight (lbs)	135	230	480	785
Approx. X Pilot System	19.00	21.00	31.00	36.00
Approx. Y Pilot System	10.00	11.00	18.00	20.00
Approx. Z Pilot System	10.00	11.00	18.00	20.00

<b>660-73</b> <b>Valve Selection</b>	<b>100-31 Pattern:</b> Globe (G), Angle (A), <b>End Connections:</b> Flanged (F) Indicate Available Sizes				
	Inches	4	6	8	10
Main Valve 100-31	Pattern	G, A	G, A	G, A	G
	End Detail	F	F	F	F
Suggested Flow (gpm)	Maximum	580	1025	2300	4100
Suggested Flow (Liters/Sec)	Maximum	37	65	145	258

**100-31 Series is the reduced internal port size version of the 100-30 Series.**

### CSM11 Solenoid Control Power Consumption

Volts	Amperes		Volts	Amperes		Coil Resistance
DC	Holding	Pull In	AC 60 Hz	Holding	Inrush	Ohms
24	.603	24	24	2.88	25.4	0.5
28	.629	120	120	.575	5.1	14.1
32	.500	208	208	.330	2.93	40
48	.293	240	240	.288	2.54	58
115	.122	440	440	.156	1.38	174
125	.119	480	440	.143	1.27	233
252	.072	2.45				
			Volts	Amperes		Coil Resistance
			(AC 50 Hz)	Holding	Inrush	Ohms
			110	.48	4.6	15.7
			220	.24	2.3	66
			240	.22	2.1	88

### CSM11 Solenoid Control

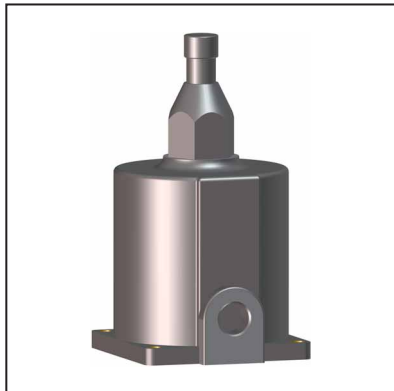

### How to Order

#### When Ordering, Please Specify:

1. Catalog No. 660-73
2. Valve Size
3. Pattern - Globe or Angle
4. Pressure Class
5. Trim Material
6. Electrical Selection
7. Desired Options
8. When Vertically Installed
9. Epoxy Coating

### CSM11 Specifications



**Enclosure** General purpose NEMA Type 3; Aluminum  
**Note:** For other enclosures and NEMA Types, consult factory

**Housing** Body — Aluminum  
 Trim — Stainless Steel

**Operating Pressure:** Maximum pressure 300 psi, for higher pressure consult factory. AC or DC

**Coil Insulation** Class A (molded)

**AC voltage** 15.4 watts

**DC voltage** 16.8 watts

### Pilot System Specifications

#### Temperature Range

Water to 180°F Max

#### Materials

Standard Pilot System Materials

Pilot Control: Low Lead Bronze

Trim: Stainless Steel Type 303

Rubber: Buna-N® Synthetic Rubber

Optional Pilot System Materials

Pilot Systems are available with optional Aluminum, Stainless Steel or Monel materials.

### Optional Electronic Control



The Cla-Val PC-22D provides control of the pump and pump control valve, preventing surges in the system when the pump starts or stops. It consists of a pre-wired electrical control panel employing a programmable valve controller to sequence the pump and pump control valve during all modes of operation. Provides added protection to the pumping system from damage caused by mechanical, hydraulic or power failure.

The PC-22D offers all the control features found in the recommended wiring diagrams for Cla-Val pump control valves, plus alarms, automatic shutdown and adjustable timers.

## Sequence Of Operation

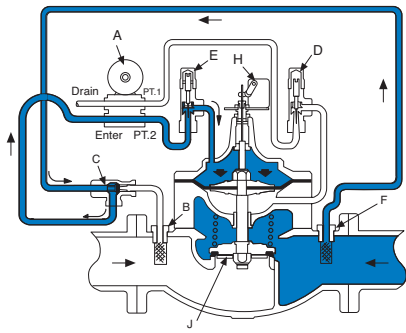

### Pump Off...

With pump off, static line pressure is transmitted through strainer "F", shuttle valve "C", solenoid control "A", and speed control "E" to the chamber above the diaphragm, thus holding the valve closed. If power failure occurs when valve is open, the built-in check valve "J" closes immediately to prevent reverse flow.

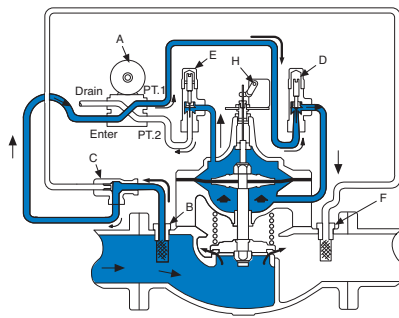

### Starting Cycle...

Starting switch closes, pump starts, solenoid control "A" energizes and shifts allowing fluid from upper diaphragm chamber to drain to atmosphere. High pressure fluid from pump enters strainer "B" and shifts shuttle valve "C", which always supplies the highest pressure from either strainer "B" or "F". High pressure fluid is transmitted to the lower diaphragm chamber and opens the valve. The opening speed of the valve is controlled by speed control "E", which limits the rate fluid is relieved from above the diaphragm.

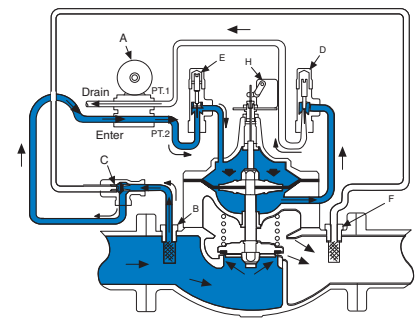

### Stopping Cycle...

Starting switch opens, solenoid control "A" de-energizes and shifts, pump continues to run. High Pressure fluid from the pump is directed above the diaphragm, applying force to close the valve. The valve closes slowly as fluid from the lower diaphragm chamber is gradually released to atmosphere through speed control "D" and solenoid "A". When the valve closes fully, the limit switch "H" shuts off the pump.

## Model 660-73 Flow Chart Uses Basic Valve Model 100-31

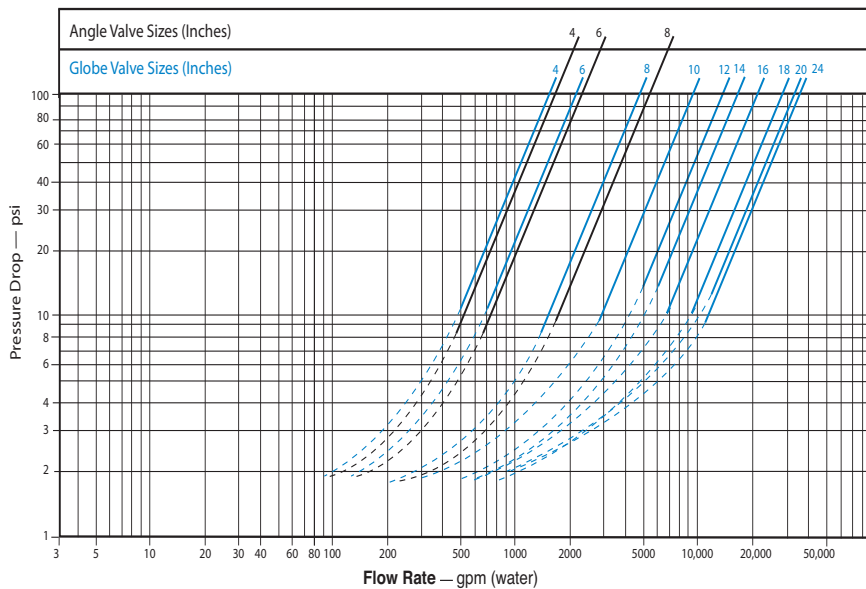

## Valve Sizing

Sizing Model 660-73 Booster Pump Control Valves is similar to sizing non-modulating type valves. Simply select the smallest size valve that will handle the pump output at an acceptable head loss for the application.

**Do not oversize.** Oversizing a Booster Pump Control Valve will nullify its ability to prevent surges caused by the starting and/or stopping of the pump. Maximum flow values are given in the selection table above. For further information on flow characteristics for this valve, reference the 100-31 (660-73) technical data sheet.

### Example:

A booster pump station with a rated output of 1000 GPM and 4 psi is an acceptable head loss for the application.

## Drain Provisions

Each time the valve opens or closes, water is discharged from the solenoid exhaust port, the amount varying with the valve size. Provisions should be made for the disposal of this water. Exhaust tube must be free of any back pressure. Provide an air gap between the solenoid exhaust tube and drain facility.

Liquid Volume Displaced from Diaphragm Chamber When Valve Opens or Closes				
Sizes (Inches)	4"	6"	8"	10"
60-73	.169gal	.531gal	1.26gal	2.51gal