



# Model XP2F-X35

*Metering Package*



## **Installation / Operation / Maintenance**

Written for Version 2.0.0



## Table of Contents

1	Introduction .....	5
2	X117H Valve Position Transmitter .....	6
3	X141-PT Pressure Transmitters.....	7
4	X35 Flow Calculation Module .....	8
4.1	Installation .....	9
4.1.1	Valve Mounted.....	9
4.1.2	Flat Surface Mount.....	10
4.1.3	Installing Wire Cable Glands .....	11
4.2	Electrical Wiring .....	12
4.2.1	Overview .....	12
4.2.2	X35 Power Supply .....	12
4.2.3	Analog Inputs .....	12
4.2.4	Analog Outputs .....	14
4.2.5	Digital Output.....	15
4.2.6	Standard Wiring Diagram.....	16
4.3	Navigation Options .....	18
4.3.1	Display Navigation Map .....	18
4.3.2	WI-FI Navigation Map .....	19
4.4	Display Configuration Setup.....	20
4.4.1	Initial Display Configuration.....	20
4.4.2	DPM Setup .....	22
4.4.3	I/O Setup .....	25
4.4.4	Calibration.....	29
4.4.5	Display Options .....	30
4.4.6	Logging .....	31
4.4.7	WI-FI.....	33
4.4.8	Date/Time .....	34
4.4.9	Language .....	34
4.4.10	Factory Reset.....	35
4.4.11	Security .....	35
4.5	WI-FI Configuration Setup.....	36
4.5.2	WI-FI Setup.....	37



- 4.5.3 DPM Setup ..... 38
- 4.5.4 I/O Setup ..... 43
- 4.5.5 Calibration ..... 49
- 4.5.6 WI-FI settings ..... 51
- 4.5.7 Display Options ..... 52
- 4.5.8 Loggings..... 53
- 4.5.9 Date/Time ..... 54
- 4.5.10 Language ..... 55
- 4.5.11 Factory Reset..... 56
- 4.5.12 Security ..... 57
- 4.6 SD Card Features..... 58
  - 4.6.1 SD Card Removal ..... 58
  - 4.6.2 Access Logged Data..... 59
- 4.7 Firmware Update ..... 60
  - 4.7.1 Firmware Version ..... 60
  - 4.7.2 Firmware Download..... 60
  - 4.7.3 SD Card Removal ..... 61
  - 4.7.4 Firmware Update ..... 62
  - 4.7.5 V2.0.0 Firmware update ..... 64
  - 4.7.6 Firmware Malfunction ..... 65
- 4.8 Digital Totalizer Output..... 67
  - 4.8.1 Digital Totalizer Output Configuration..... 67
  - 4.8.2 Digital Output..... 69
  - 4.8.3 Digital Totalizer Output Plug-In Board ..... 69
- 5 XP2F-X35 START-UP CHECKLIST ..... 71
  - 5.1 Control Valve Setup ..... 71
  - 5.2 Component Configuration ..... 71
  - 5.3 X35 Wiring Configuration..... 71
  - 5.4 X35 Power Activation..... 71
  - 5.5 X35 DPM Setup ..... 71
  - 5.6 X35 I/O Setup ..... 72
  - 5.7 X35 Display Options Setup..... 73
  - 5.8 X35 Configuration Logging Setup..... 73



- 5.9 X35 Date/Time Setup ..... 73
- 5.10 X35 Analog Input Mapping and Signal ..... 74
- 5.11 Valve Position Setup and Zero Calibration..... 74
- 5.12 Flow Testing and Verification..... 75
- 5.13 X35 Analog Output Mapping and Signal ..... 75
- 6 XP2F-X35 TROUBLESHOOTING GUIDE ..... 76
  - 6.1 Hardware Troubleshooting ..... 76
  - 6.2 Software Troubleshooting ..... 77
- Appendix A: Wiring schematic setup ..... 78
  - A.1 2x X141-PTs and X117D ..... 78
  - A.2 DP Transmitter and X117D..... 79

## 1 Introduction

The XP2F-X35 is a low cost, robust, state of the art package that can accurately meter the flow through a Cla-Val valve. To meter the flow, the XP2F-X35 assimilates data from valve mounted pressure transmitters and a position transmitter. Using a proprietary algorithm, the flow rate through the valve is calculated and shown on a local display. The XP2F-X35 provides 4-20mA analog outputs to retransmit the calculated flow, measured pressures, and measured position transmitter to a nearby PLC/SCADA system. The XP2F-X35 also logs all data to a local SD card which can be exported in CSV file format for analysis later.

The XP2F-X35 package is an ideal solution for users that need to monitor flow for control or reporting purposes. The XP2F-X35 offers several advantages over traditional flow meter options. Due to it mounting to an existing Cla-Val valve, it's much easier to retrofit into a system than most other flow meters (e.g. mag meter which requires the pipeline to be cut for installation). Additionally, there is minimal straight pipe upstream or downstream requirements for the XP2F-X35 to accurately meter flow.

In the standard setup, the XP2F-X35 package consists of an upstream and downstream pressure transmitter, a valve position transmitter, and a calculation module as depicted in **FIGURE 1.1** below:

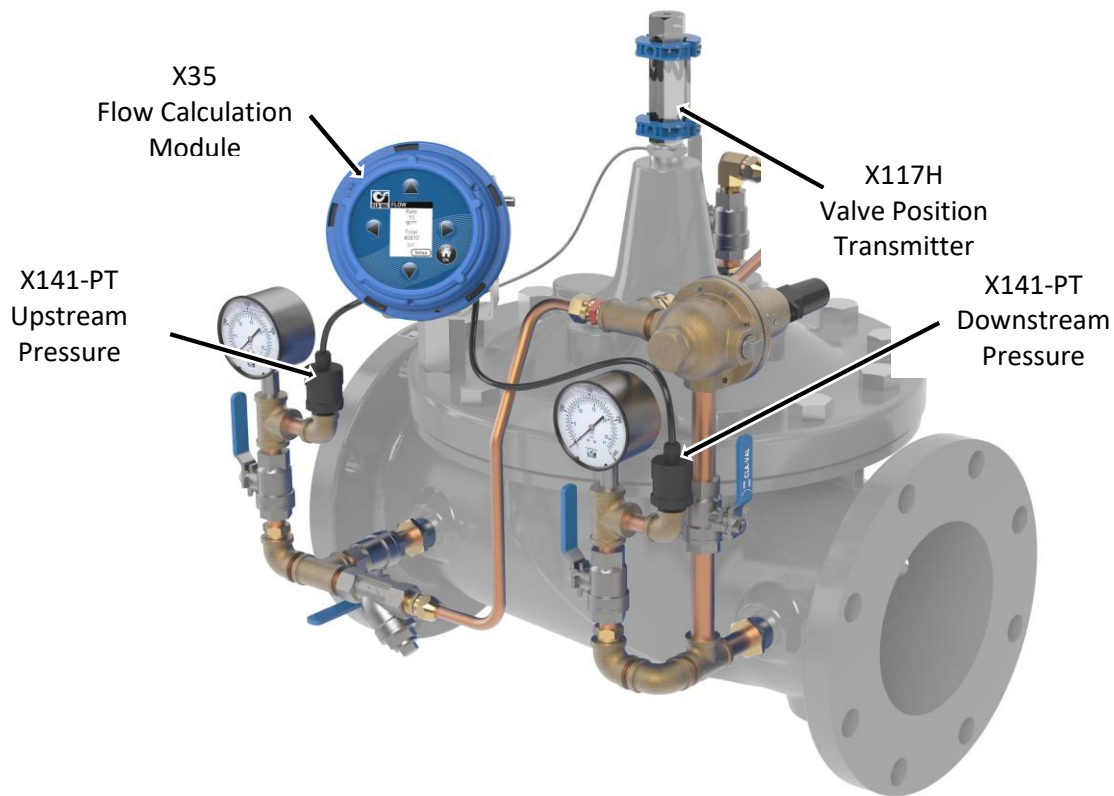

Figure 1.1

The XP2F-X35 package can be customized with different components. The upstream and downstream pressure transmitters can be substituted with a differential pressure transmitter. Additionally, the XP2F-X35 comes standard with a Cla-Val X117H position transmitter (as shown in **FIGURE 1.1**) but can be used with a Cla-Val X117D position transmitter as well.

## 2 X117H Valve Position Transmitter

The Cla-Val Model X117H Valve Position Transmitter is an accurate monitor of the valve position. Through an industry standard 4-20mA, the X117H delivers accuracy within 100 micrometers. This position transmitter easily provides the accuracy required for computer-guided control valve systems (SCADA). The sensor requires a supply voltage of 15-30 VDC. Power can be supplied by *either* the X35 or an external power source.

The X117H consists of two main parts: the X101D Position Indicator and the X117H Sensor Assembly. The X117H can be retrofit to almost any Cla-Val valve. The X117H also includes a newly designed indicator body which allows for easier bleeding in any situation. The new body includes a weep hole above the sight glass (see **Figure 2.1**) that can be opened via a set screw mounted in the top of the position indicator. This greatly reduces the likelihood of misplacing or breaking the bleed screw while allowing easy removal of air from the indicator housing.



Figure 2.1



Figure 2.2

The position sensor used in this assembly utilizes 3 LED's to allow the user to monitor device status visually (**Figure 2.2**).

For further installation or troubleshooting information please refer to the corresponding **X117H N-sheet**.

### 3 X141-PT Pressure Transmitters

The Cla-Val Model X141-PT consists of a pressure transmitter installed with isolation valves mounted on the main valve inlet and/or outlet. The rugged design provides resistance to vibration, shock, wide temperature variations, RFI and other extreme environmental conditions. Performance and reliability are enhanced by the all-stainless steel welded measuring cell that eliminates the need for soft sealing materials that may deteriorate over time.

The X141-PT pressure transmitter can be installed on new or existing valves on the valve inlet and/or outlet. The 141-PT transmitters can be paired with Cla-Val Model X141 Pressure Gauges for both local and remote valve pressure information. Default configuration for the XP2F-X35 package includes 2 pressure transmitters, one for upstream pressure and one for downstream pressure. The transmitter requires a supply voltage of 8-30 VDC. This transmitter will output an industry standard 4-20 mA signal when using the default 2-wire setup. The X141-PT will provide an accuracy of  $\pm 0.5\%$  of the span.

There is no field calibration or internal setup required for the X141-PT. If needed, zero-point calibration can be done on whatever controller is being used. For wiring examples, refer to Error! Reference source not found..



Figure 3.1

## 4 X35 Flow Calculation Module

The Cla-Val X35 Flow Calculation Module is the centerpiece of the XP2F-X35 metering package. The X35 Module is responsible for handling all the input and output signals in the XP2F-X35 package. The X35 has four 4-20mA inputs and four 4-20mA outputs. The standard inputs include Valve Position, Upstream and Downstream Pressure Transmitters or a single DP Transmitter. The fourth input is reserved as a spare which can log or retransmit data from any additional 4-20mA field device.

To calculate the metered flow, the X35 assimilates data from valve-mounted pressure transmitters and a position transmitter. Using a proprietary algorithm, the flow rate through the valve is calculated and shown on the local X35 display. The X35 provides 4-20mA analog outputs to retransmit the calculated flow, measured pressures, and measured position to a nearby PLC/SCADA system. The X35 also logs all data to a local SD card which can be exported automatically or manually in CSV file format for later analysis. Continue below for installation, wiring, and configuration.

for detailed wiring information. Refer to Error! Reference source not found. for menu info and advanced configuration.

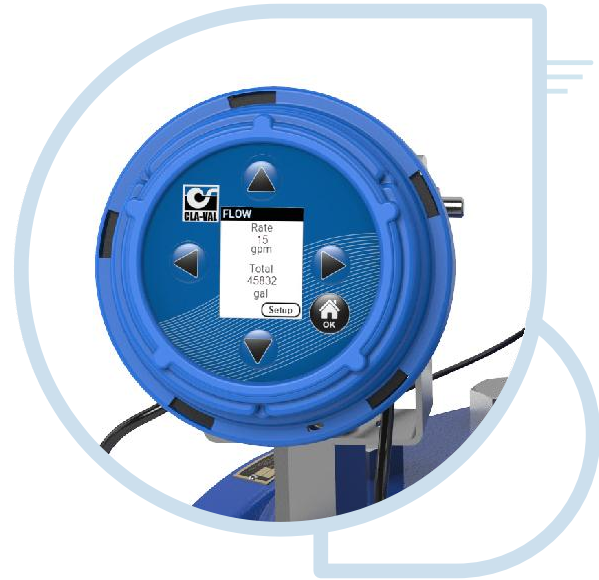

Figure 4.1

## 4.1 Installation

The X35 Flow Calculation module can be mounted directly on a valve, on a nearby flat surface (e.g., an electrical enclosure door or wall mounted).

### 4.1.1 Valve Mounted

To mount the X35 flow calculation module directly on a valve, assemble the X35 on the included rotating support bracket along with the X56 valve cover standoff supports using the fasteners as depicted in the **Figure 4.2**.



Figure 4.2

#### 4.1.2 Flat Surface Mount

To mount the X35 calculation module on a flat surface as shown in **Figure 4.3**, assemble the calculation module on the included rotating support bracket using the fasteners depicted in **Figure 4.4**.

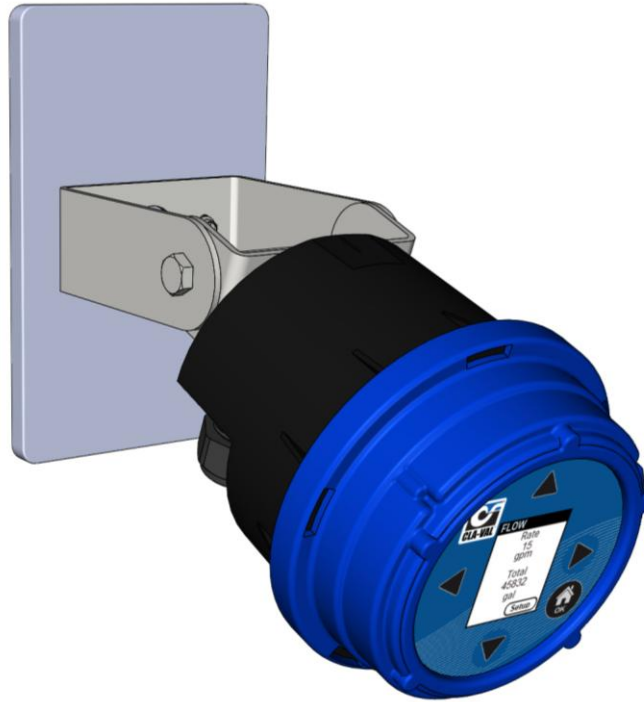

Figure 4.3

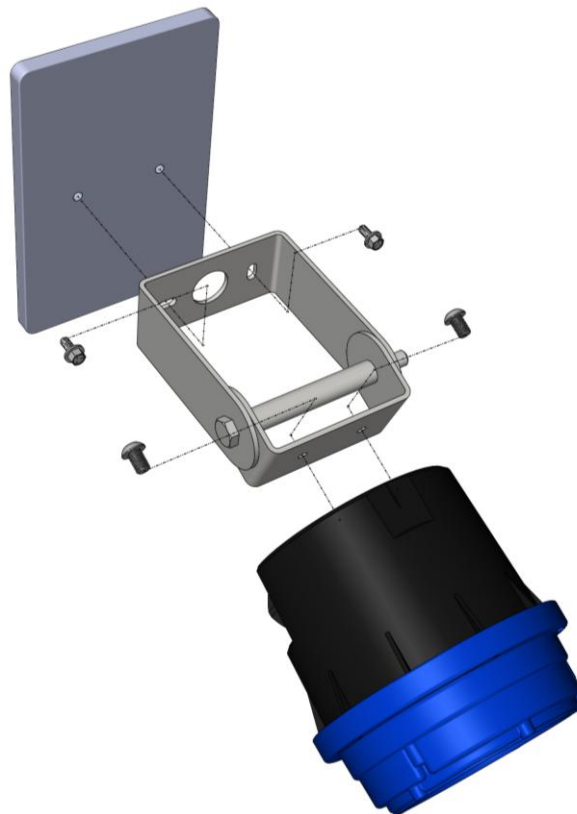

Figure 4.4

#### 4.1.3 Installing Wire Cable Glands

Included with the X35 are multiple 3-hole, 2-hole, and blank glands. These will need to be selected and installed based on the number of wires coming and going from the X35 housing. To ensure IP68 rating, please match the number of holes to the number of wires. Examples can be seen in **Figure 4.5**.

**WARNING:** DO NOT leave any holes/glands open. Blanks can be used to block an entire port or if a custom sized hole needs to be drilled.

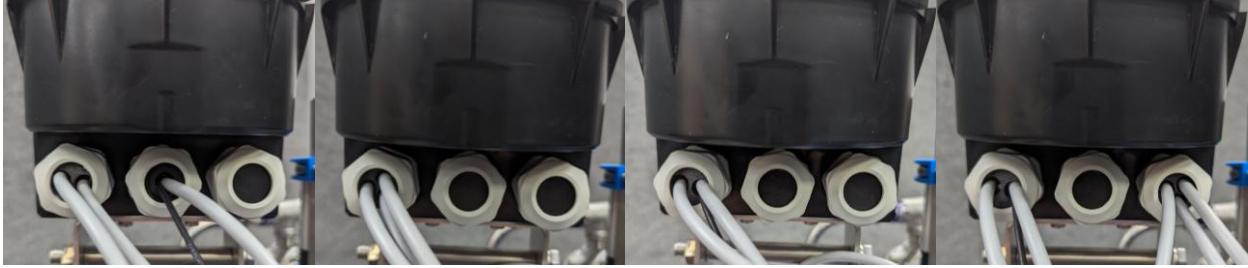

Figure 4.5 – 4 wire config (1x 2hole, 1x drilled blank), 3 wire config (1x 3hole), 3 wire config (1x 2hole), 6 wire (1x 2hole, 1x 3hole)

## 4.2 Electrical Wiring

### 4.2.1 Overview

The XP2F-X35 integrates several components electrically, and this section is designated to explain how those electrical connections should be made. The X35 flow calculation model is the connection point for all other components in the package, so the wiring is explained in terms of the X35.

### 4.2.2 X35 Power Supply

The X35 has the following power draw requirements:

- **9-24 VDC**
- 2.2 watt draw when screen is off
- 3.3 watt draw when screen is on

### 4.2.3 Analog Inputs

The X35 has 4 analog input channels that can accept a standard 4-20mA signal. The X35 can provide loop power to the sensor or allow the sensor to be field powered. The wiring terminals used on the X35 determine whether the analog input provides power. To have the X35 provide loop power to the sensor, see the wiring diagram in **Figure 4.**

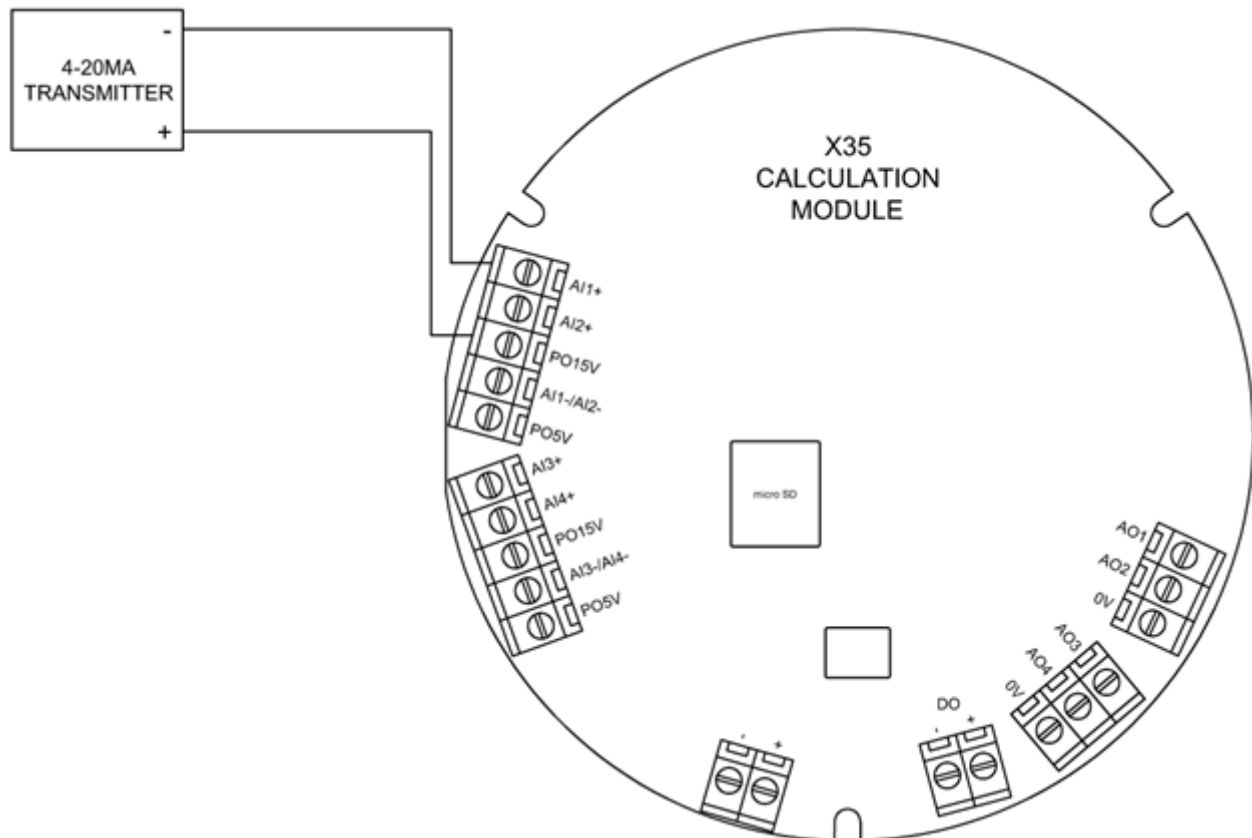

Figure 4.5

For a field powered 4-20mA signal, see the wiring diagram in **Figure 4.6**.

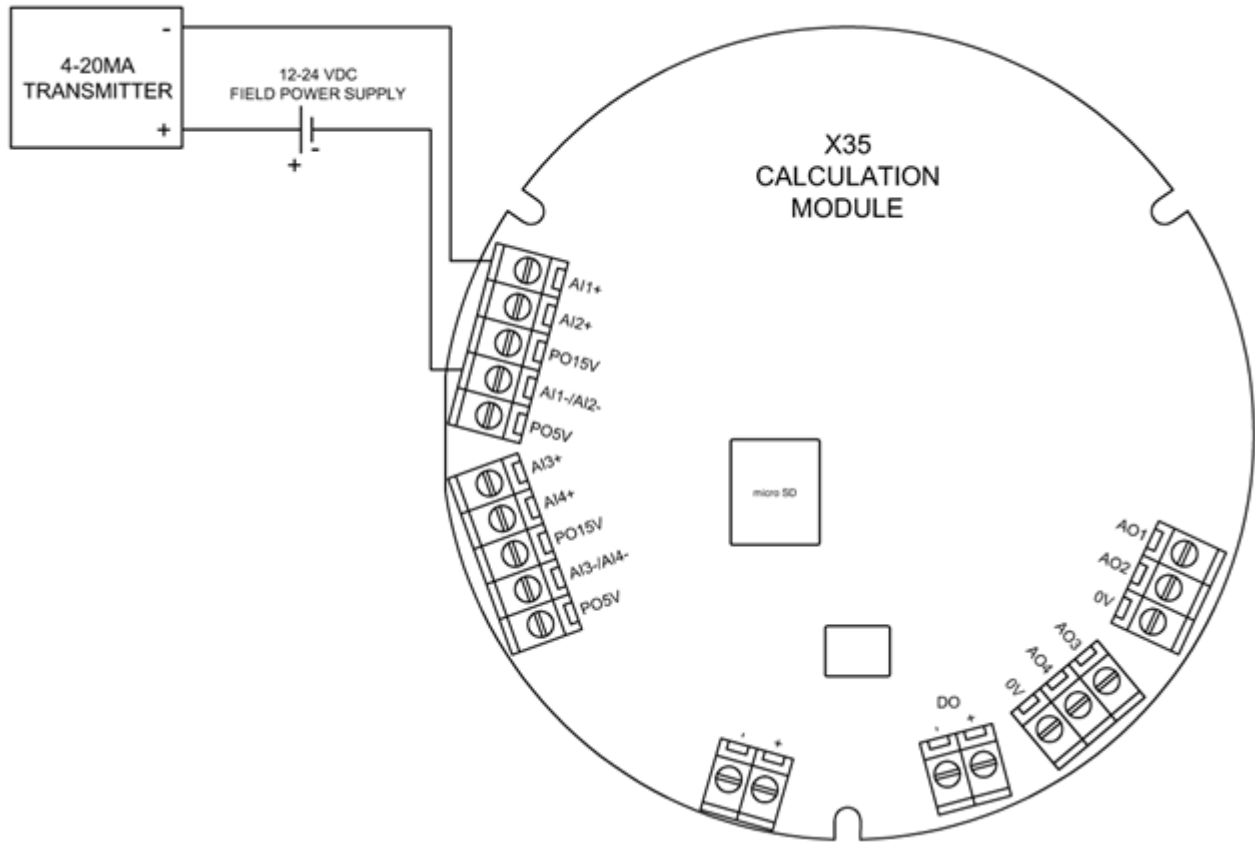

Figure 4.6

#### 4.2.4 Analog Outputs

The X35 has 4 analog outputs which transmit a standard 4-20mA signal to external devices. The analog outputs always provide loop power, and the voltage of the loop power is the same as the voltage applied to the X35 power supply (9 – 24 VDC). To have an external device (e.g. SCADA/PLC) receive the 4-20mA signal from the X35, wire the device as shown in **Figure 4.7**.

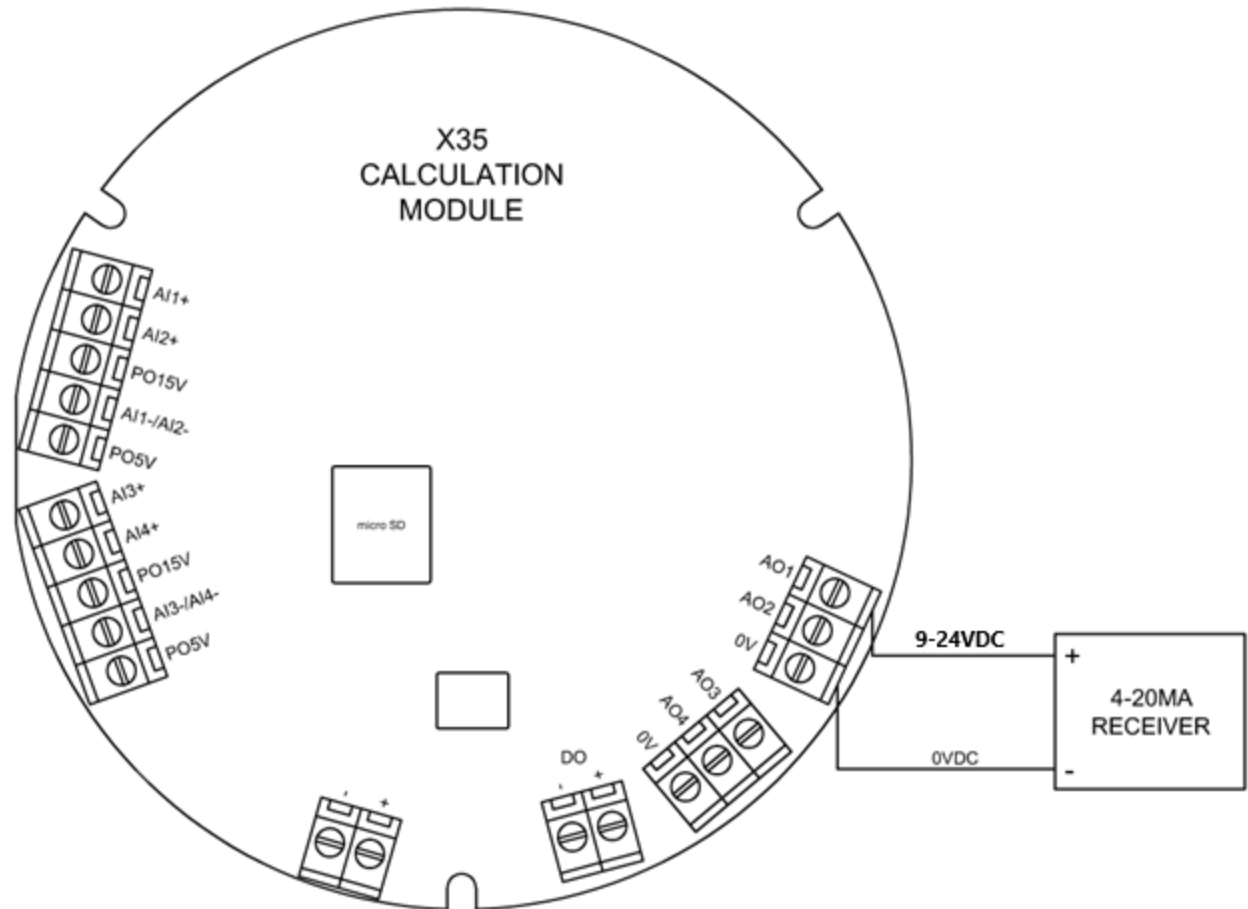

Figure 4.7



### 4.2.5 Digital Output

Some users want to totalize the flow using pulsed output instead of a 4-20mA output or in accordance with it. The pulses will be proportional to flow rate, for example, number of gpm per pulse. The output can be wired into a flow computer, PLC, or external counter.

The pulse flowmeter generates the digital pulses in form of 1 and 0 when measuring flow. The more the flow the faster the pulses are generated. The X35 output pulses are generated to an input card of a PLC, RTU, etc.

To output a pulse from X35 a Plug-in board is used to convert the digital output wet contact into a dry contact which only uses pulses.

Refer to **section 4.7** for more details for Digital Totalizer Output.

4.2.6 Standard Wiring Diagram

The following wiring diagram shows how to wire the standard XP2F-X35 (2x X141-PTs and X117H). Please note, the XP2F-X35 package can be offered with multiple different components and can also be configured to use different I/O channels. The diagram depicts what is standard. For additional configurations, refer to **appendix**.

1. **Default** Analog inputs and analog signal retransmission if DPM inputs is P1 + P2, refer to **section 4.4.2.4 DPM inputs**.

Analog Input	Description	Analog Output	Description
<b>AI1</b>	Valve Position	<b>AO1</b>	Flow
<b>AI2</b>	Inlet Pressure	<b>AO2</b>	Valve Position
<b>AI3</b>	Outlet Pressure	<b>AO3</b>	Inlet Pressure
<b>AI4</b>	Spare	<b>AO4</b>	Outlet Pressure

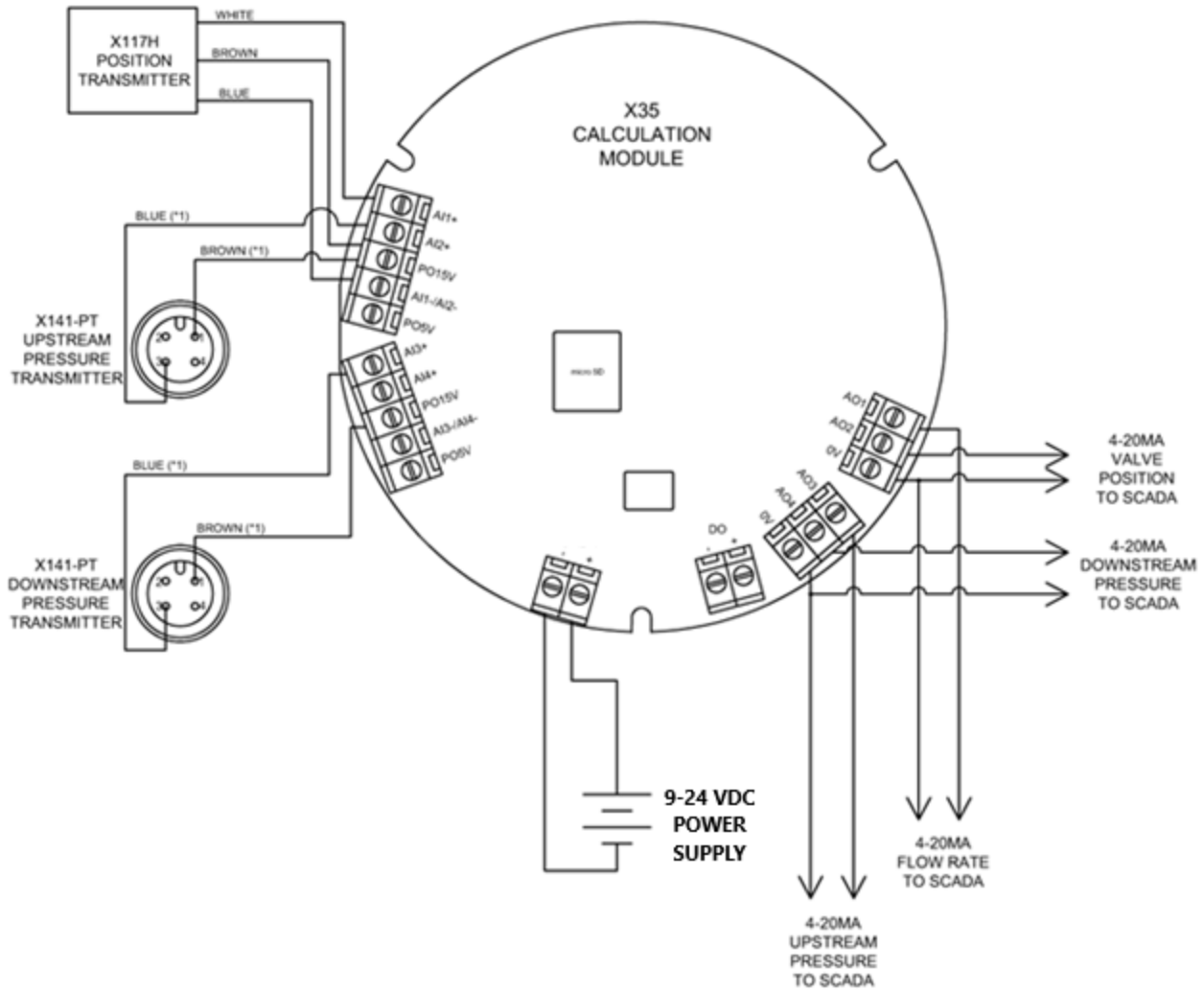

Figure 4.8

2. **Default** analog inputs and analog signal retransmission if DPM inputs is Delta P, refer to **section 4.4.2.4** DPM inputs.

Analog Input	Description	Analog Output	Description
<b>AI1</b>	Valve Position	<b>AO1</b>	Flow
<b>AI2</b>	Differential Pressure	<b>AO2</b>	Valve Position
<b>AI3</b>	Spare 1	<b>AO3</b>	Differential Pressure
<b>AI4</b>	Spare 2	<b>AO4</b>	None

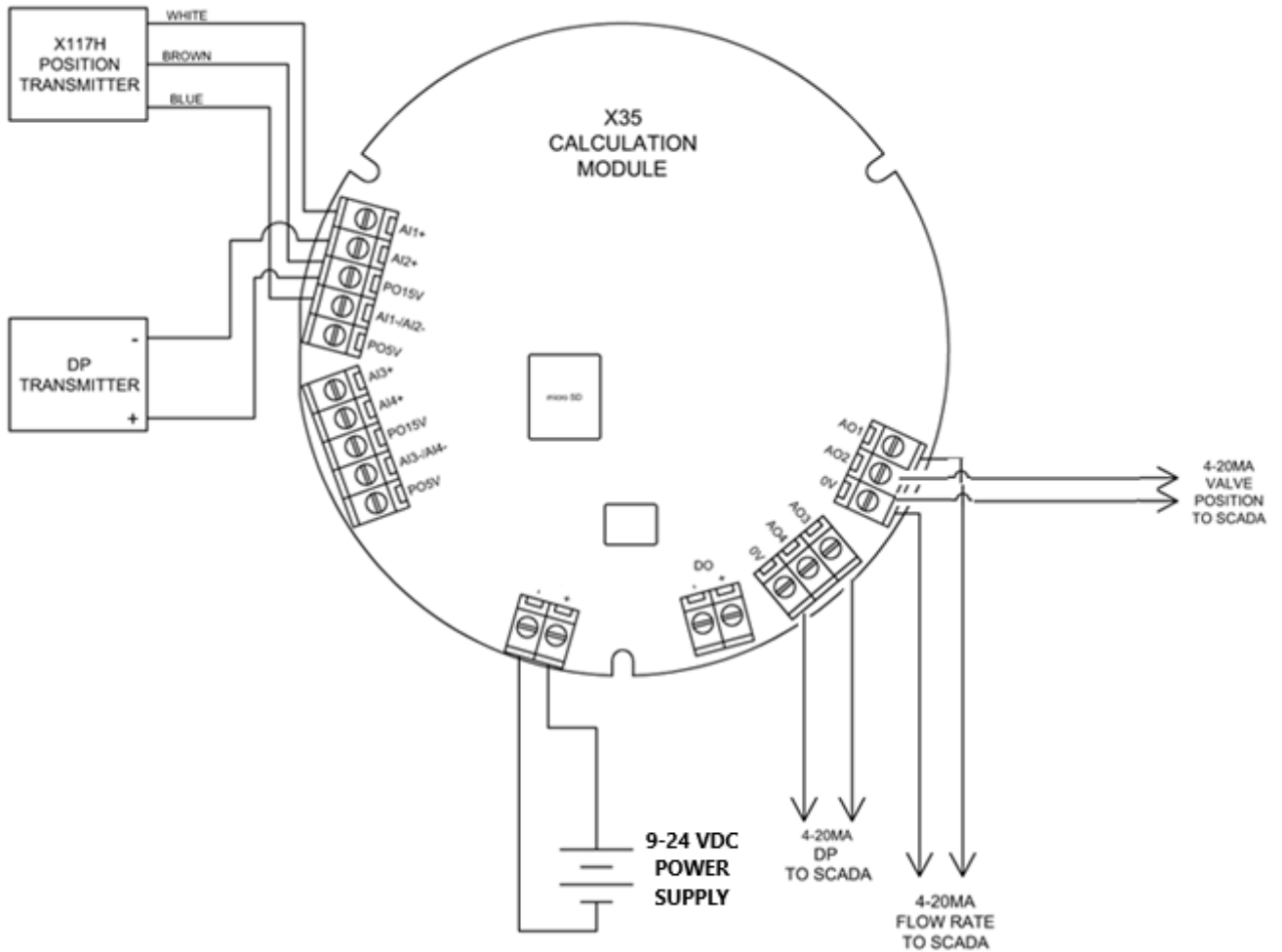

Figure 4.9

### 4.3 Navigation Options

#### 4.3.1 Display Navigation Map

FIGURE 4.10 below provides a screen map which shows how to navigate to various screens on the X35 display.

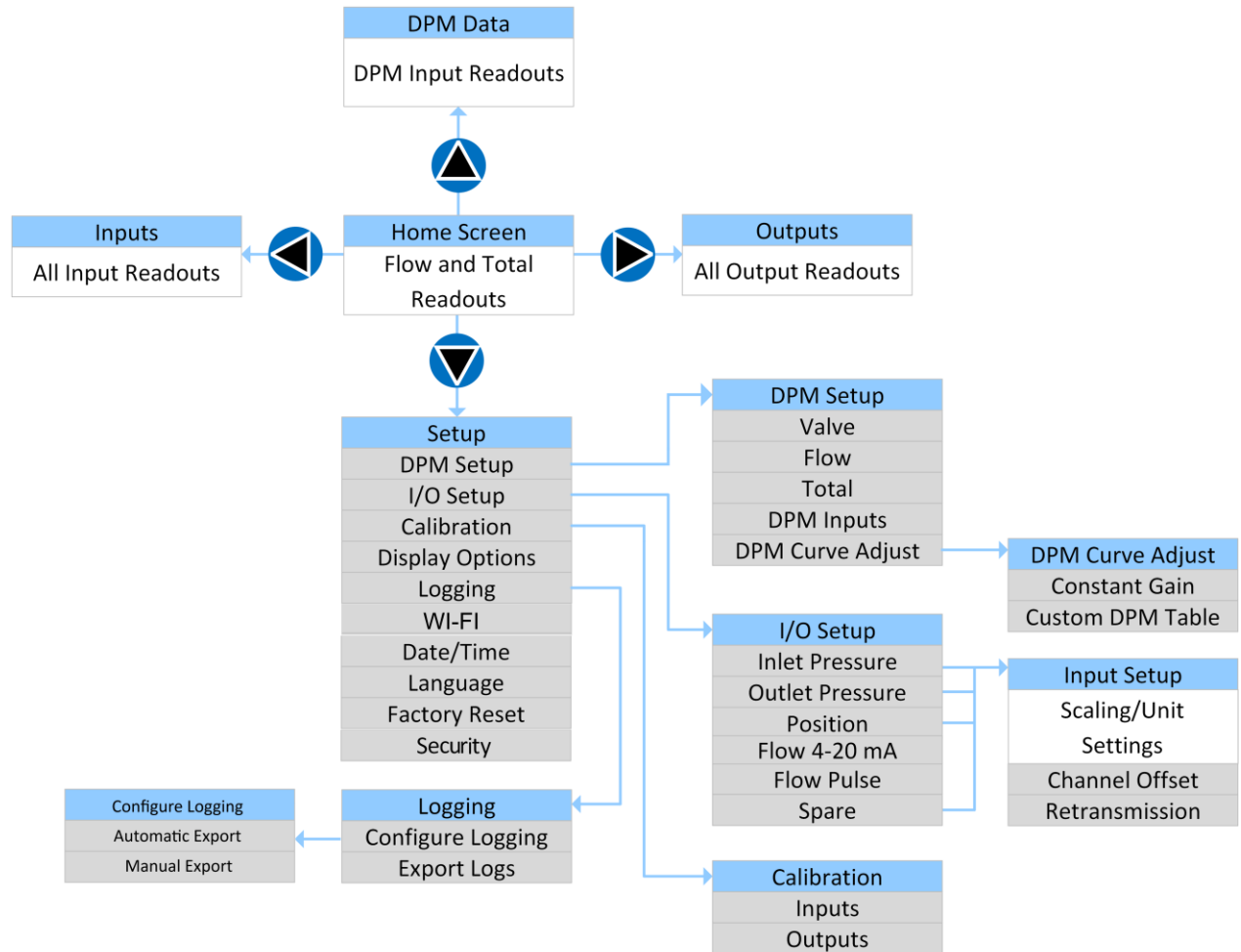

Figure 4.10

4.3.2 WI-FI Navigation Map

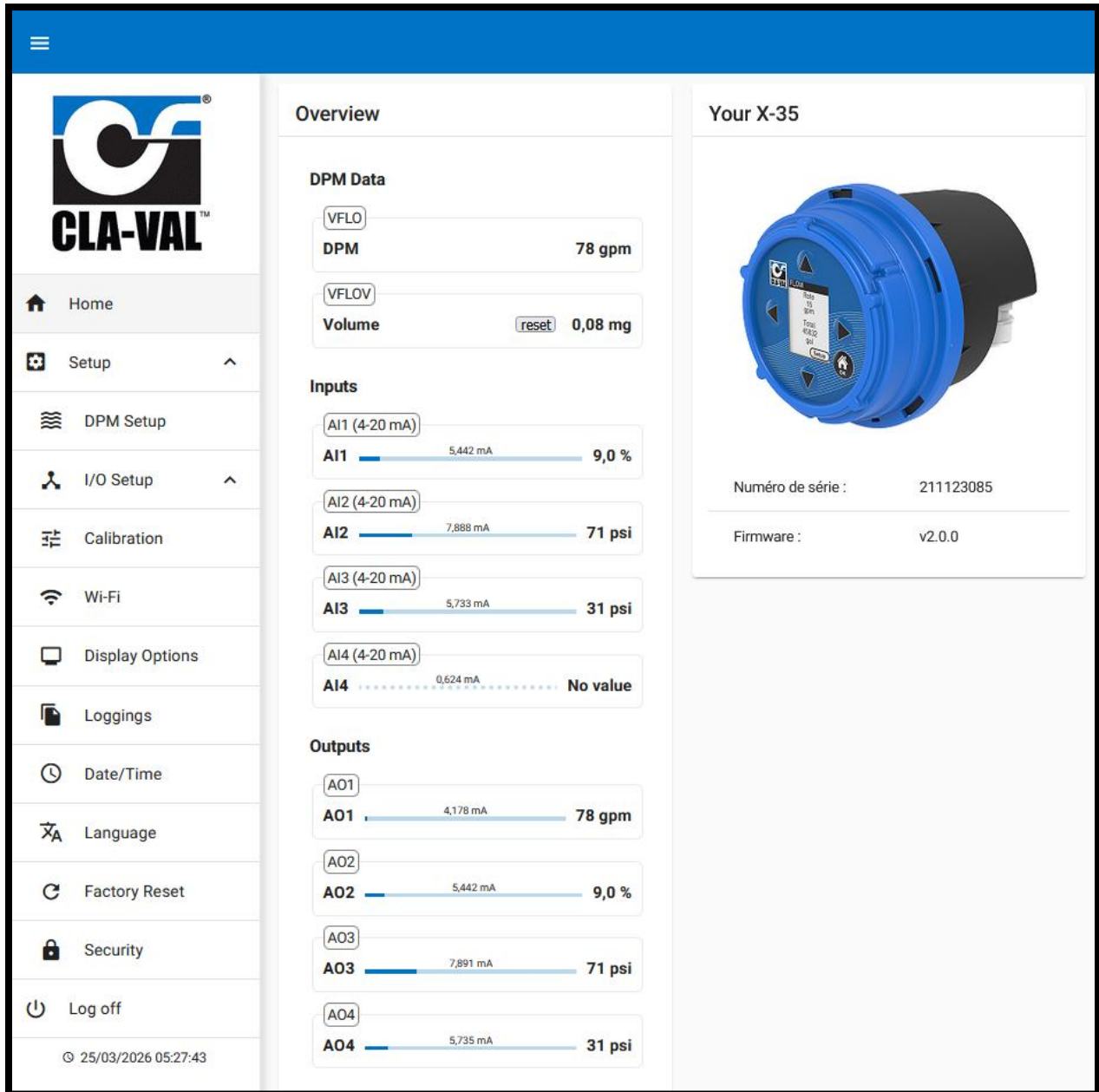

Figure 4.11

#### 4.4 Display Configuration Setup

The following subsections describe what appears in the settings on each screen and provide detailed explanations.

**refer to section 5 for X35 setup using the WI-FI Configuration.**

##### 4.4.1 Initial Display Configuration

After the XP2F-X35 components are installed and wired, provide power to the X35 calculation module.

Configure the unit following the steps below.

1. Starting at the home screen, use the navigation arrows to highlight “Setup” as shown below and press OK.

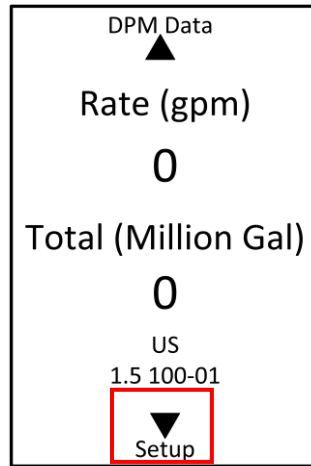

Figure 4.12

2. Select “DPM Setup”

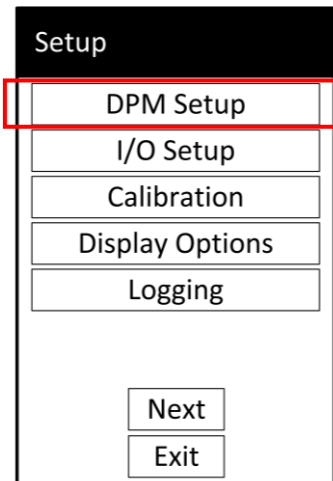

Figure 4.13

3. Select "Valve"

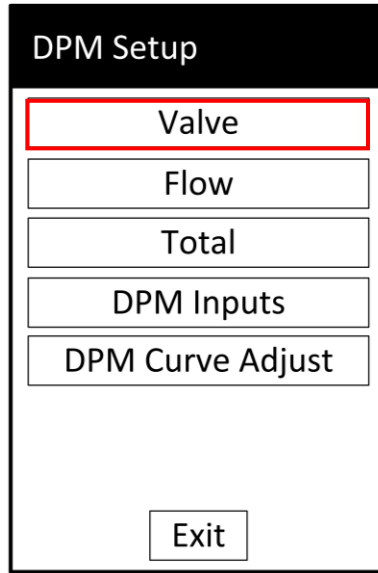

Figure 4.14

4. Fill out the form to tell the X35 what type of valve it's calculating flow for and then press exit. In the example below, the following valve information was entered on the form:
  - a. Units: US (refers to the engineering units of valve size)
  - b. Size: 1.5 (inches)
  - c. Body: 100-01 (refers to a full ported valve)
  - d. Seat Type: Standard (indicates no anti-cavitation trim)
  - e. S. Loc: Boss-Boss (indicates the pressure transmitters are on the valve inlet/outlet boss ports)
  - f. Flow Direction: Normal (indicates flow is not going in reverse through the valve)

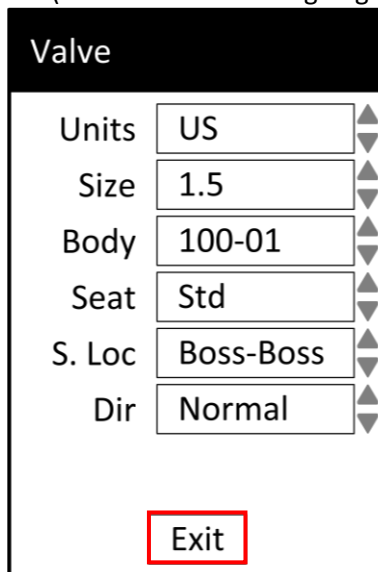

Figure 4.15

5. Return to the home screen by pressing and holding the OK button for 2 seconds. The XP2F-X35 package is now ready for operation.

4.4.2 DPM Setup

4.4.2.1 Valve

**Description:** Allows the user to tell the X35 specifics about the valve, pressure sensor locations, and flow direction that are needed so flow can be calculated.

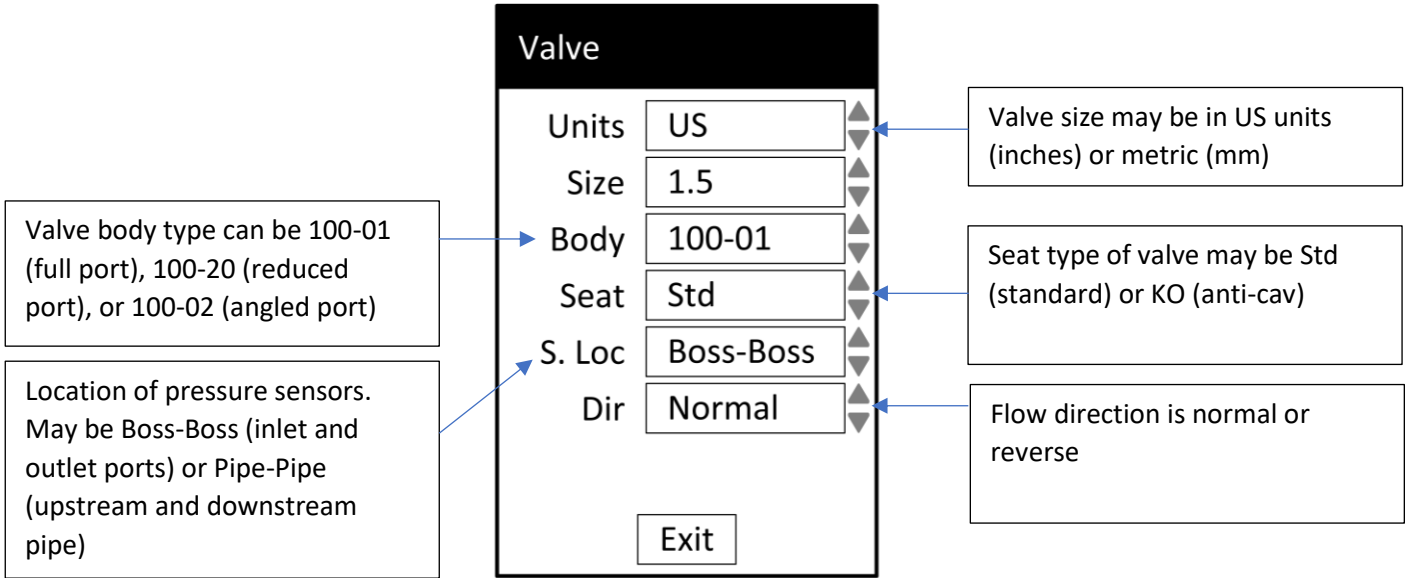

Figure 4.16

4.4.2.2 Flow

**Description:** Allows the user to configure units for flow, number of decimal points to display, and a low flow cutoff.

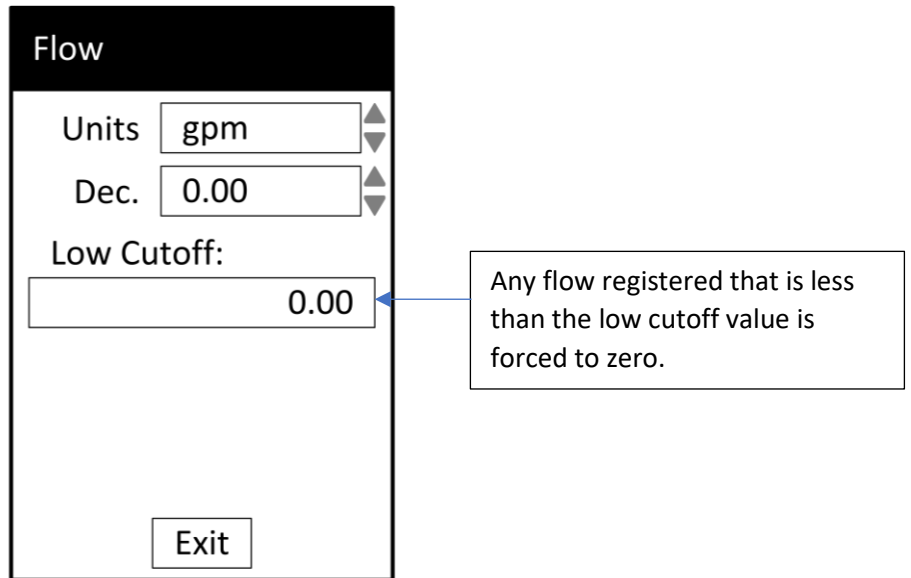

Figure 4.17

4.4.2.3 Total

**Description:** Allows the user to configure units for flow total, number of decimal points to display, and reset the flow total.

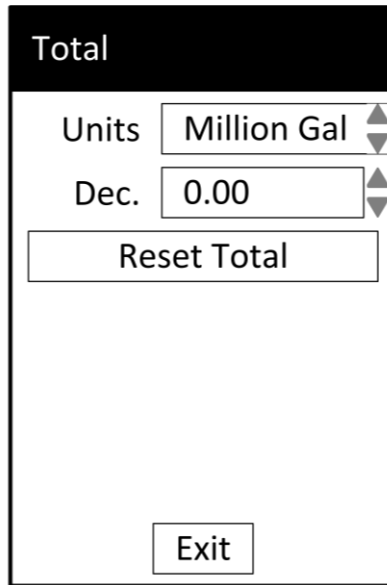

Figure 4.18

4.4.2.4 DPM Inputs

**Description:** Specifies if an upstream and downstream pressure transmitter is connected to the X35, or if differential pressure transmitter is connected to the X35.

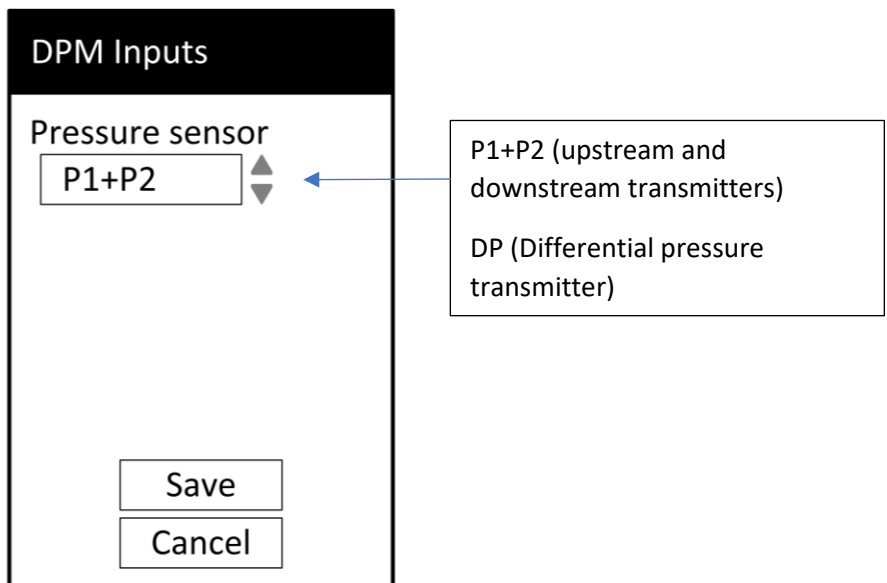

Figure 4.19

4.4.2.5 DPM Curve Adjust.

4.4.2.5.1 Constant Gain

**Description:** Multiplies the calculated flow through the valve by a user entered constant gain factor. This is used to remove a discrepancy between X35 and another flow meter. It's best to use the constant gain factor when there is a consistent percentage difference between the flow meter and the X35 regardless of valve position.

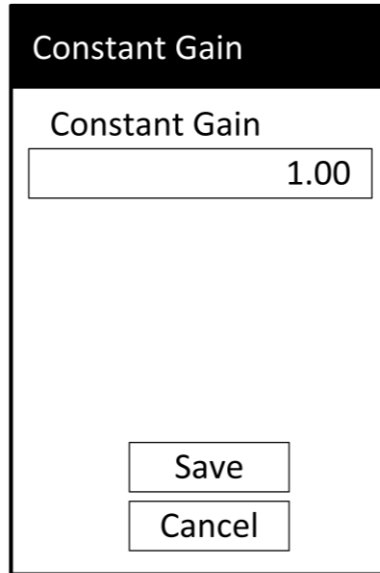

Figure 4.20

4.4.2.5.2 Custom DPM Table

**Description:** Multiplies the calculated flow through the valve by a user entered constant factor. The user can enter different gain factors for specific valve positions. This is used to remove a discrepancy between X35 and another flow meter when the discrepancy varies as the valve opens more.

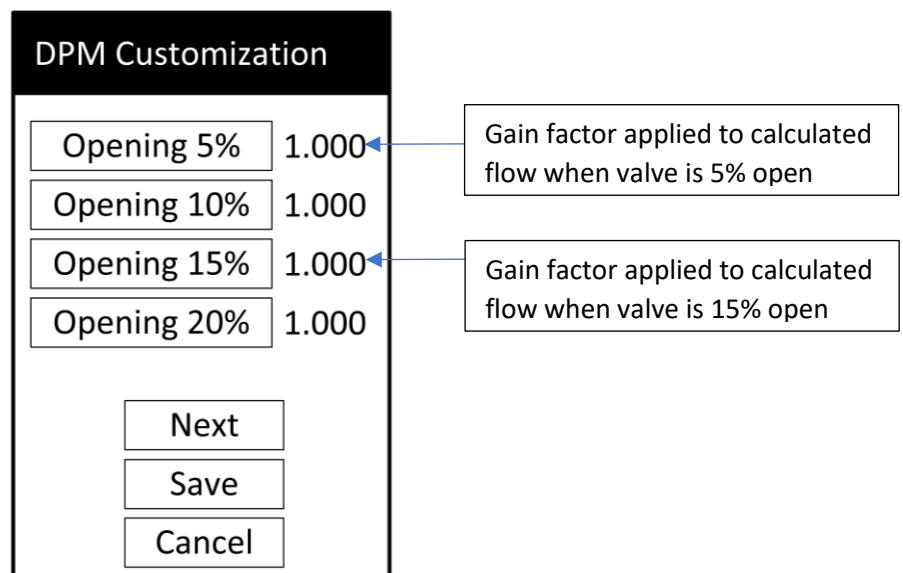

Figure 4.21

When selecting a gain factor and pressing OK to make an adjustment, the X35 will display prompts as shown in **FIGURE 4..**

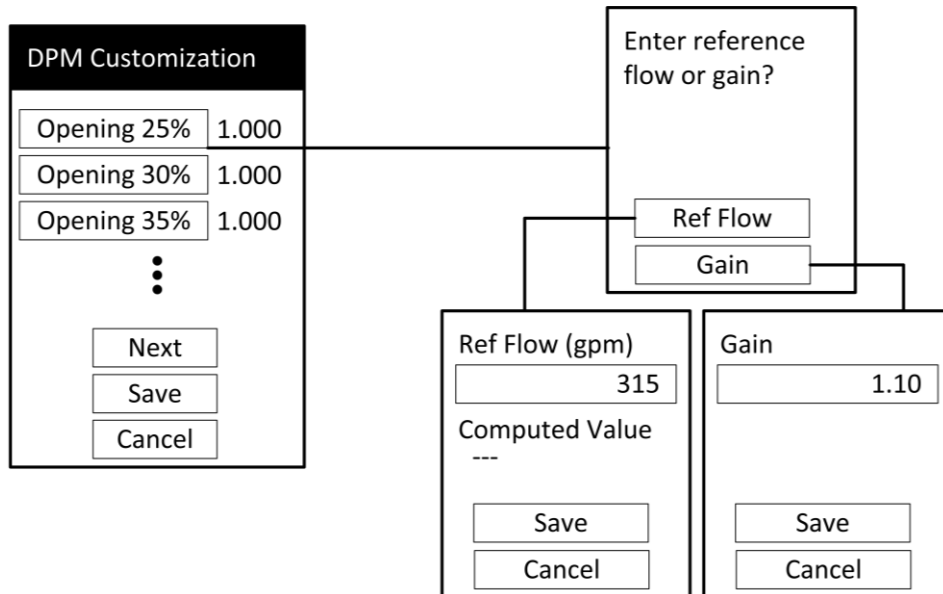

Figure 4.22

When prompted to “Enter reference flow or gain?”, if “Ref Flow” is selected, then you’re allowed to enter the flow displayed on another flow meter and the appropriate gain factor will be calculated and applied. If “Gain” is selected, then you’re allowed to directly enter a desired gain factor.

#### 4.4.3 I/O Setup

**Description:** Lists all input channels to the X35 and the flow output channel. If an input channel is selected (Inlet Pressure, Outlet Pressure, Position, or Spare), then the input setup screen is displayed. If the flow output channel is selected, then the retransmission setup screen is displayed as in **Figure 4..**

The Input Setup screen shown in **FIGURE 4.** allows for input settings to be entered such as channel assignment, scaling, engineering units, and more.

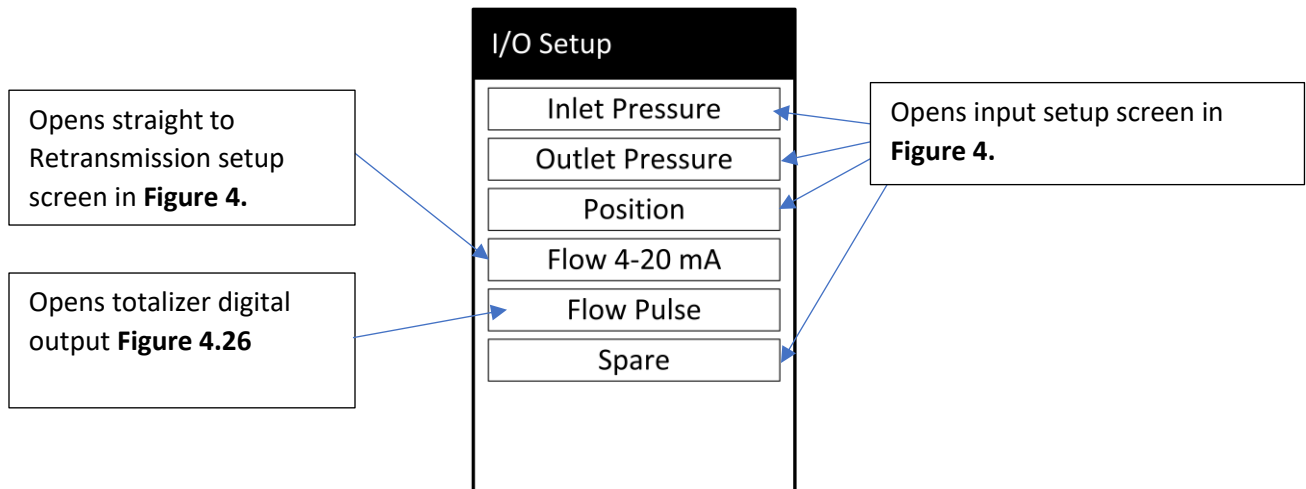

Figure 4.23

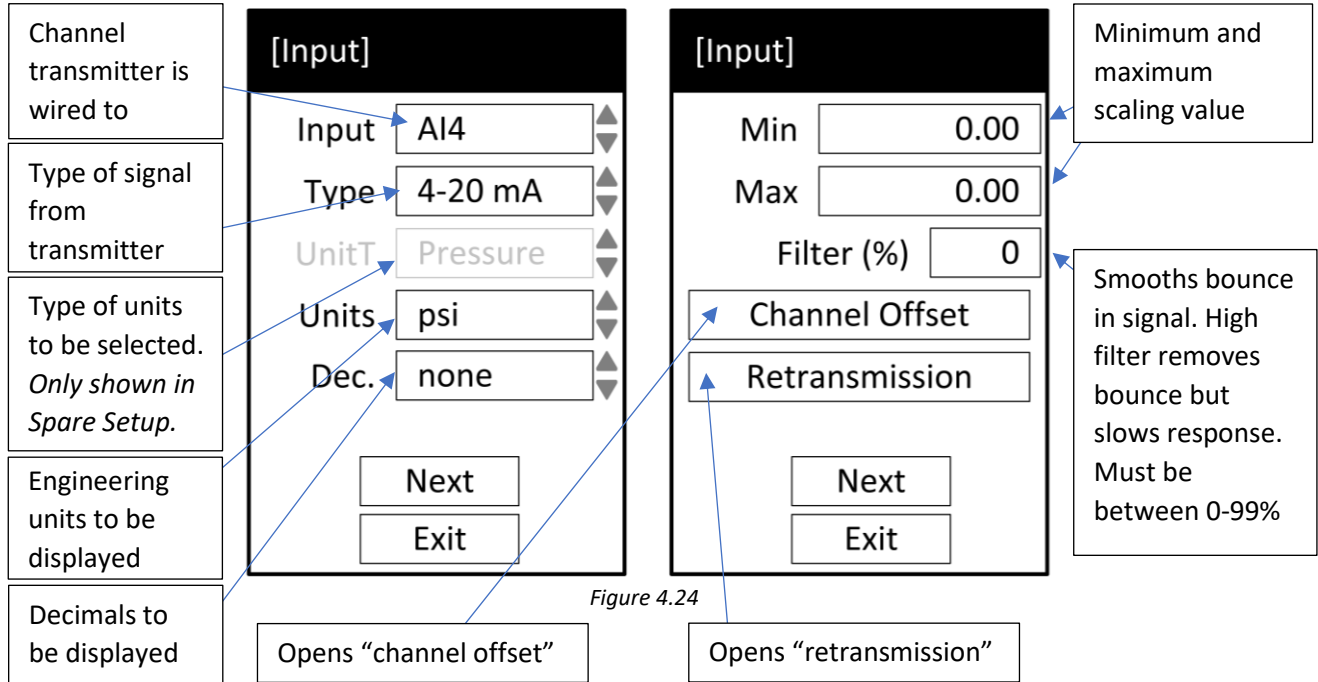

Figure 4.24

The Channel Offset page shown in **FIGURE 4.** allows the engineering value from the input to be increased or decreased by a fixed amount. For example, if the currently measured value is 5 psi but a mechanical gauge indicates it should be 7 psi, a targeted new value of 7 psi may be entered which will offset the measured value by 2 psi from now on.

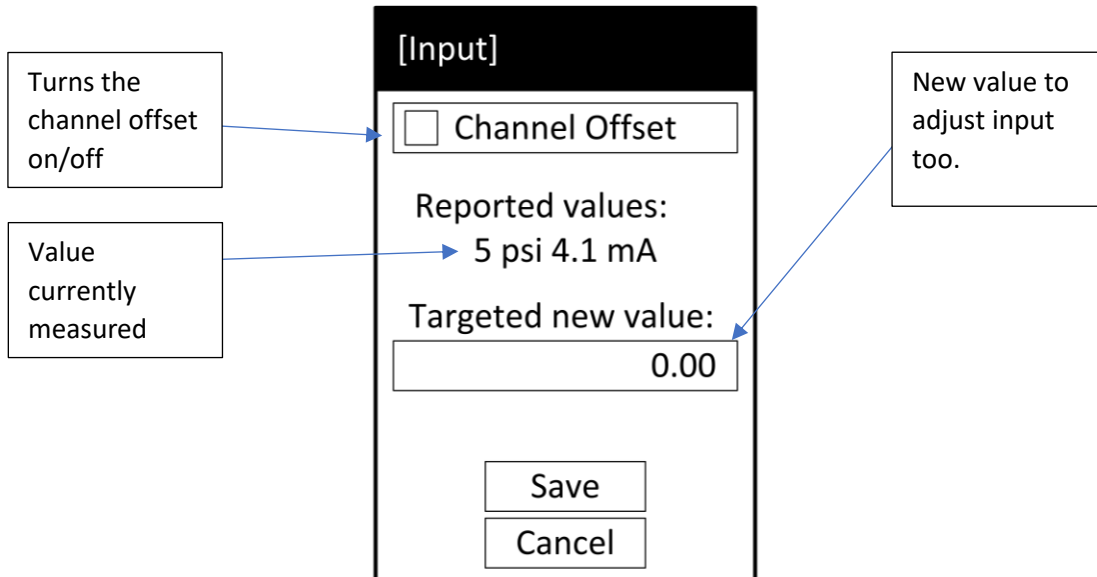

Figure 4.25

The Retransmission page shown in **FIGURE 4.** allows the signal received from the transmitter to be retransmitted via a 4-20mA output channel on the X35 to a PLC/SCADA system.

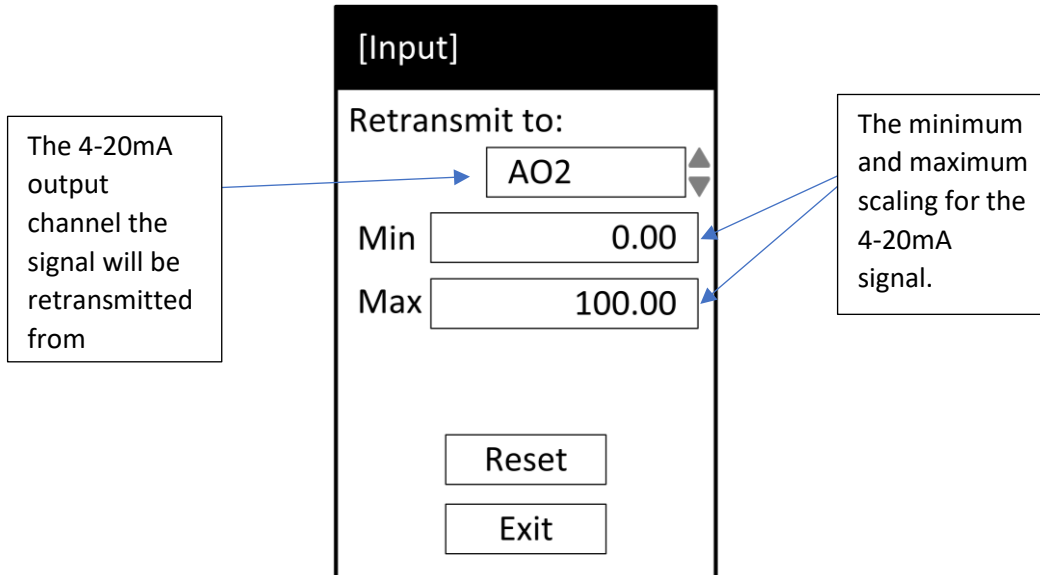
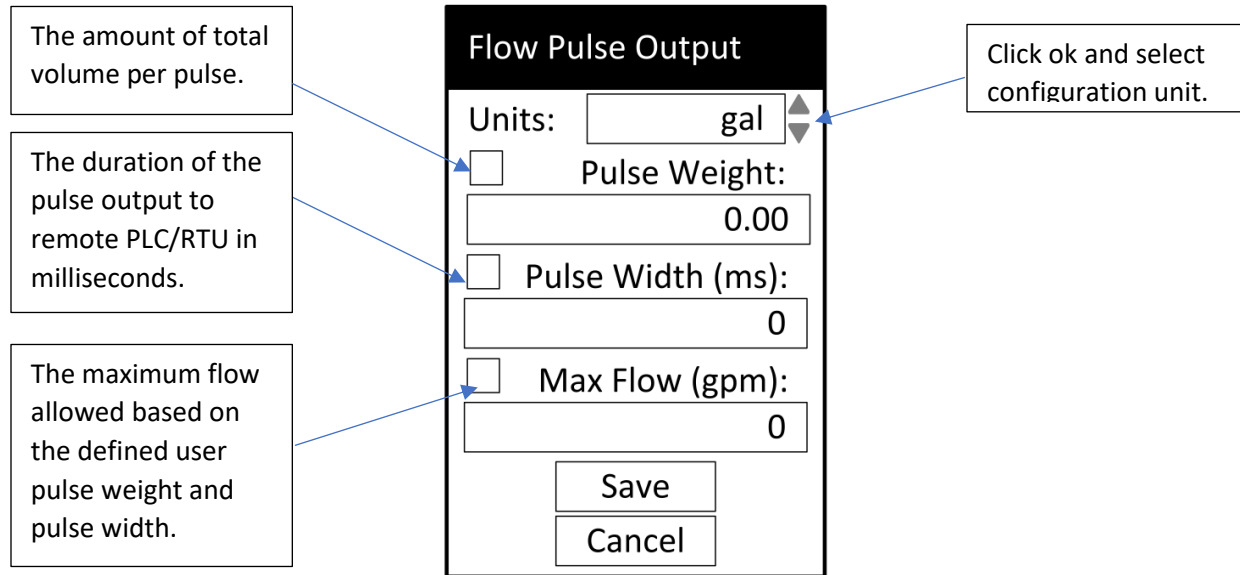

Figure 4.26

The X35 module has a default signal retransmission of the analog inputs to analog outputs which can be summarized as follows:

The Totalizer digital output in **FIGURE 4.26** allows the configuration of parameters which are generated as pulses sent to an input card of a PLC, RTU, etc.



The screenshot shows a configuration window titled "Flow Pulse Output". It contains the following fields and controls:

- Units:** A dropdown menu currently set to "gal".
- Pulse Weight:** A checkbox followed by a text input field containing "0.00".
- Pulse Width (ms):** A checkbox followed by a text input field containing "0".
- Max Flow (gpm):** A checkbox followed by a text input field containing "0".
- Buttons:** "Save" and "Cancel" buttons at the bottom.

Callout boxes provide the following descriptions:

- Points to the Units field: "The amount of total volume per pulse."
- Points to the Pulse Weight field: "The duration of the pulse output to remote PLC/RTU in milliseconds."
- Points to the Max Flow field: "The maximum flow allowed based on the defined user pulse weight and pulse width."
- Points to the Units dropdown arrow: "Click ok and select configuration unit."

Figure 4.27

4.4.4 Calibration

4.4.4.1 Inputs

**Description:** Used when the milliamps/volts measured on an input channel on the X35 differ from the value measured on a multimeter or PLC/SCADA system. Allows the discrepancy to be eliminated.

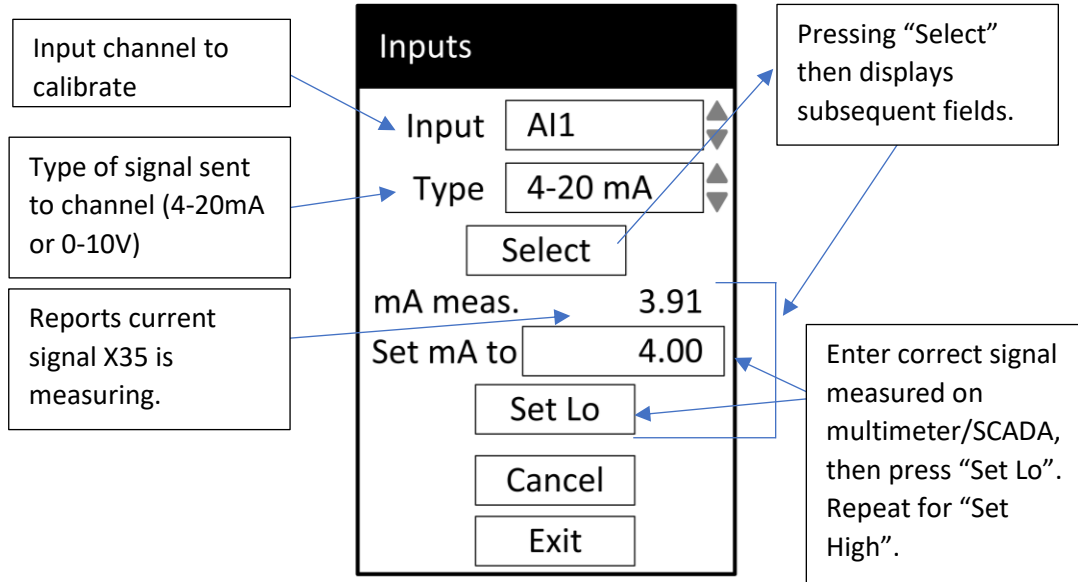

Figure 4.28

4.4.4.2 Outputs

**Description:** Used when the milliamps/volts sent from an output channel on the X35 differ from the value measured on a multimeter or PLC/SCADA system. Allows the discrepancy to be eliminated.

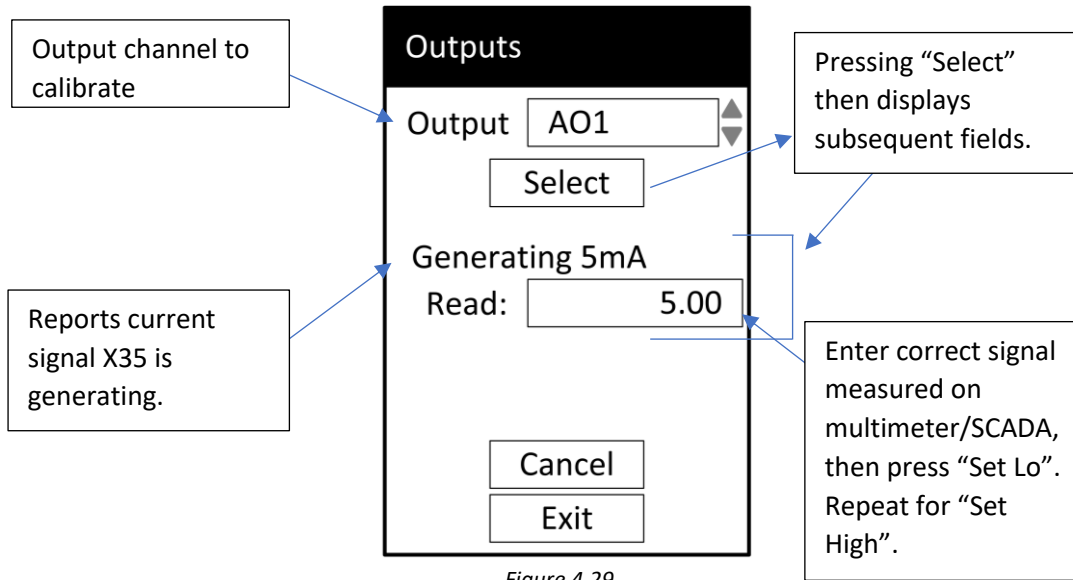

Figure 4.29

4.4.5 Display Options

**Description:** Used to modify miscellaneous display settings.

Blinking feature flash the X35 screen on and off as a visual indication to users of device normal operation when access to module is limited. X35 screen will blink on for approximately two seconds every cycle of seconds configured by user.

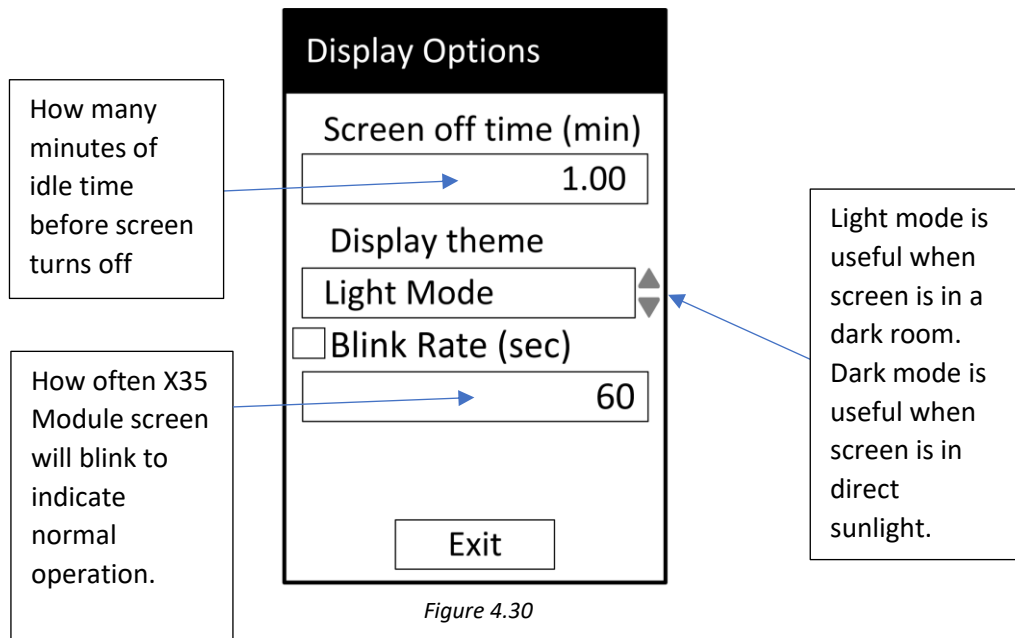

Figure 4.30

4.4.6 Logging

4.4.6.1 Configure Logging

**Description:** Used to configure when and how often log values are written to log files.

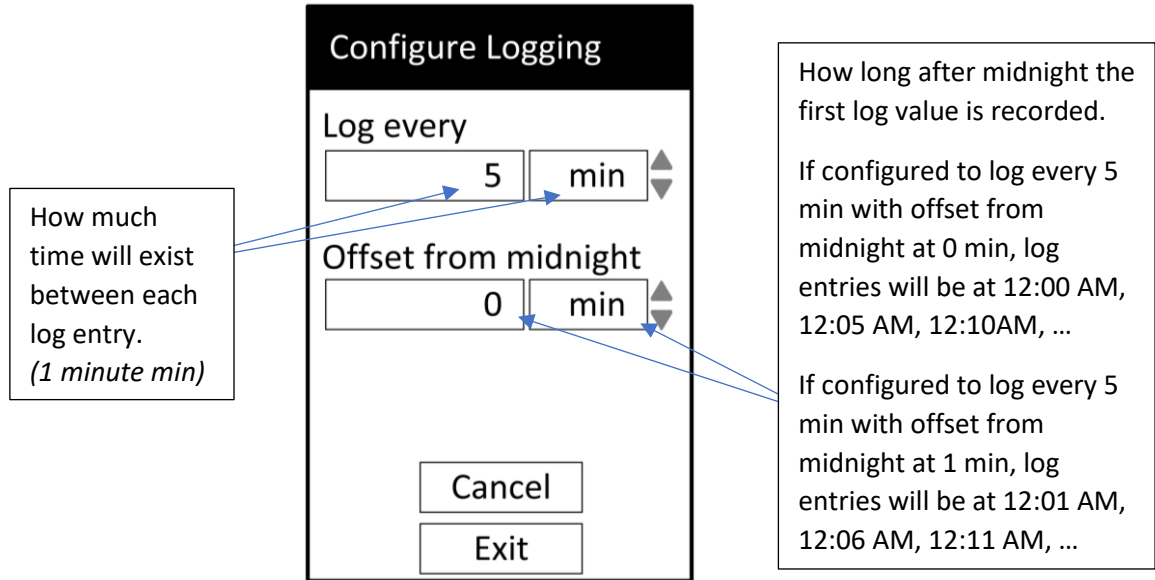

Figure 4.31

4.4.6.2 Export Log Files

**Description:** Exports the log files to the root of the SD card in the X35 in CSV format. Export of log files can be done automatically or manually. Automatic logging will provide the option of exporting log files automatically to SD card either hourly, daily, or weekly. SD card can then be removed and inserted into a computer to copy the files. For directions on removing/locating the SD card and log files, see **WI-FI Configuration Setup**

4.4.6.3 Initial WI-FI Configuration

To connect to X35, access to the WI-FI setup page is discussed in the previous section and open WI-FI settings using a computer, mobile phone, etc.

The WI-FI information is displayed in the WI-FI setup page on the X35 display along with the IP address to connect to.

**\*\*Note:** Refer to section 4.4.18 for WI-FI settings and information in X35 display.

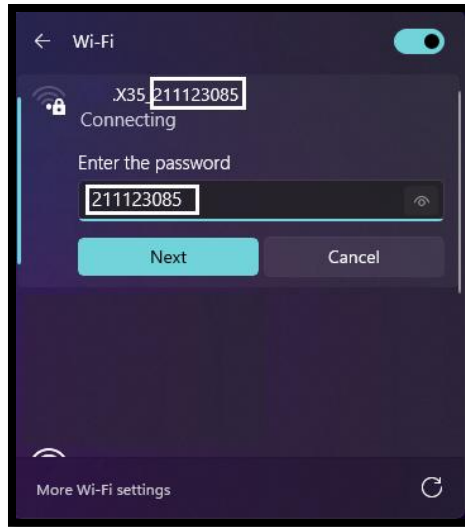

After successfully connecting to X35 WI-FI network, open a browser and type in the IP address 192.168.4.1 and click enter, WI-FI configuration setup should open and display as figure below:

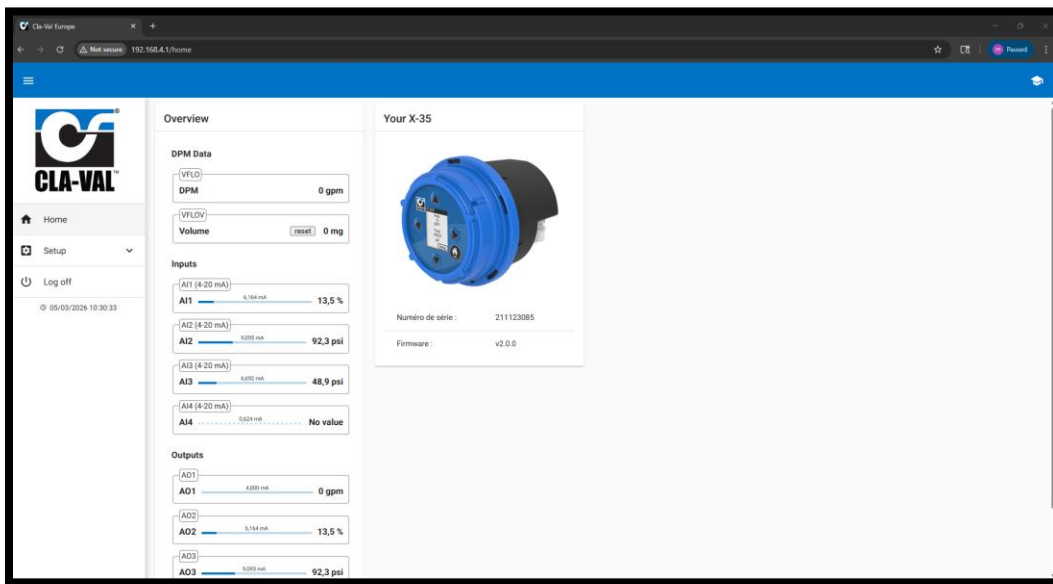

**\*\*Note: If unable to access the IP address using a browser, make sure proxy settings are disabled from browser.**

#### 4.4.7 WI-FI Setup

This section presents a complete X35 configuration setup using the WI-FI interface only and follows the same sequence as section 4.4, which uses X35 module display for configuration.

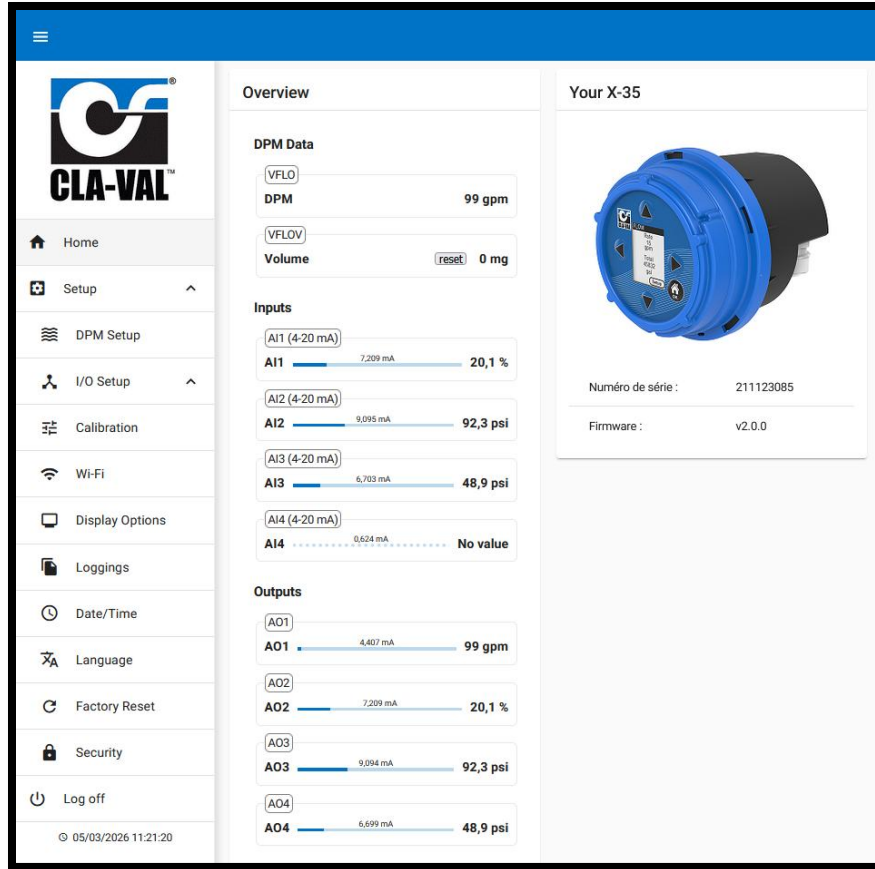

4.4.7.1 *Advanced Mode*

Advanced mode in X35 displays other configuration menus that may be required for configuration setup.

To access advanced mode in WI-FI configuration page, navigate to the top right corner of the browser

page and click on the following symbol , confirm the access request from the displayed screen below.

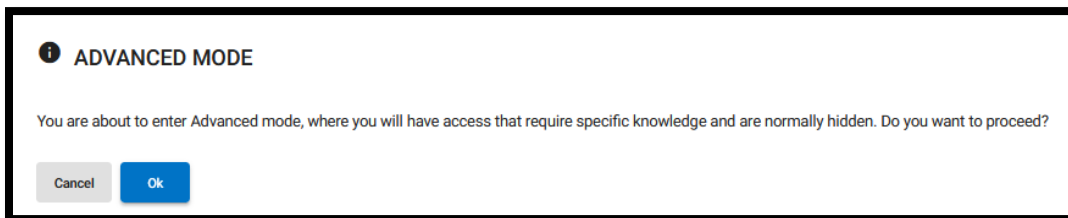



4.4.8 DPM Setup

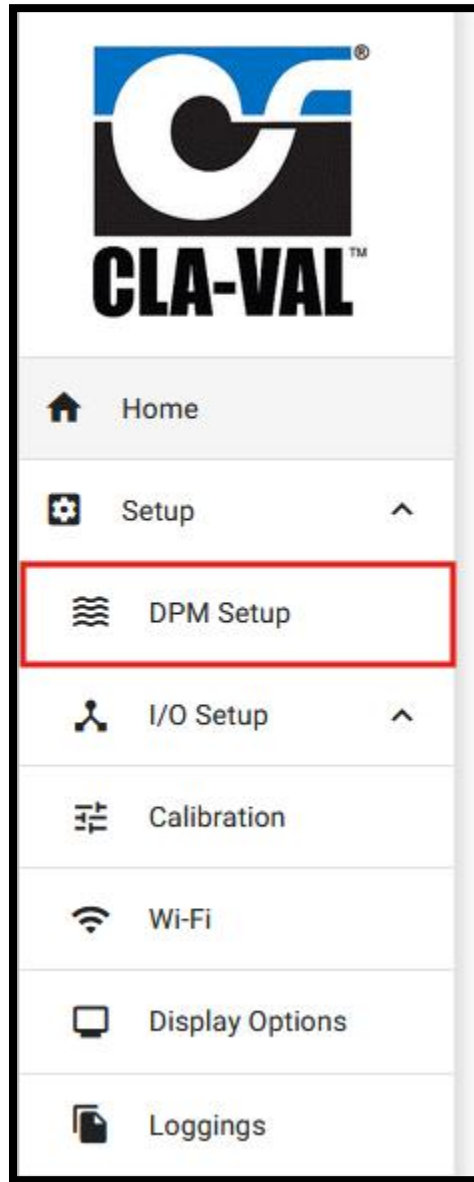



4.4.8.1 Valve

**Description:** Allows the user to tell the X35 specifics about the valve, pressure sensor locations, and flow direction that are needed so flow can be calculated.

### Configuring Flow Calculation

Decimal digits \*  
0

Low Cutoff \*  
0

DPM Input \*      Unités  
P1 + P2      gpm

table \*  
US

Size \*  
4

Body style \*  
100-01

Seat type \*  
Std

S. Loc \*  
Boss-Boss

Valve direction \*  
Reverse

**SAVE**

4.4.8.2 Total

**Description:** Allows the user to configure units for flow total, number of decimal points to display, and reset the flow total.

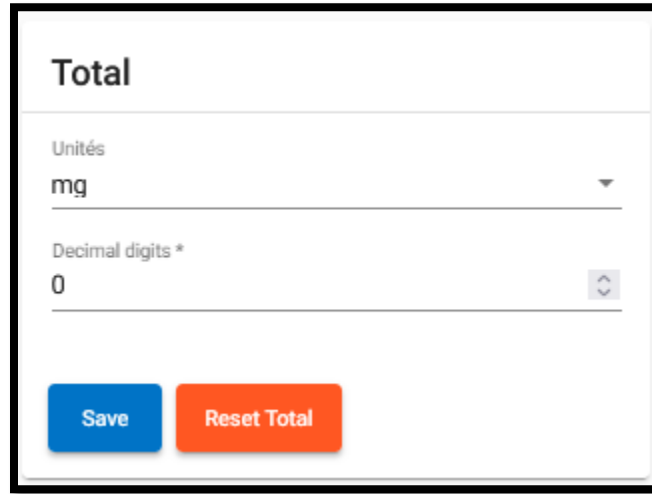

4.4.8.3 DPM Inputs

**Description:** Specifies if an upstream and downstream pressure transmitter is connected to the X35, or if differential pressure transmitter is connected to the X35.

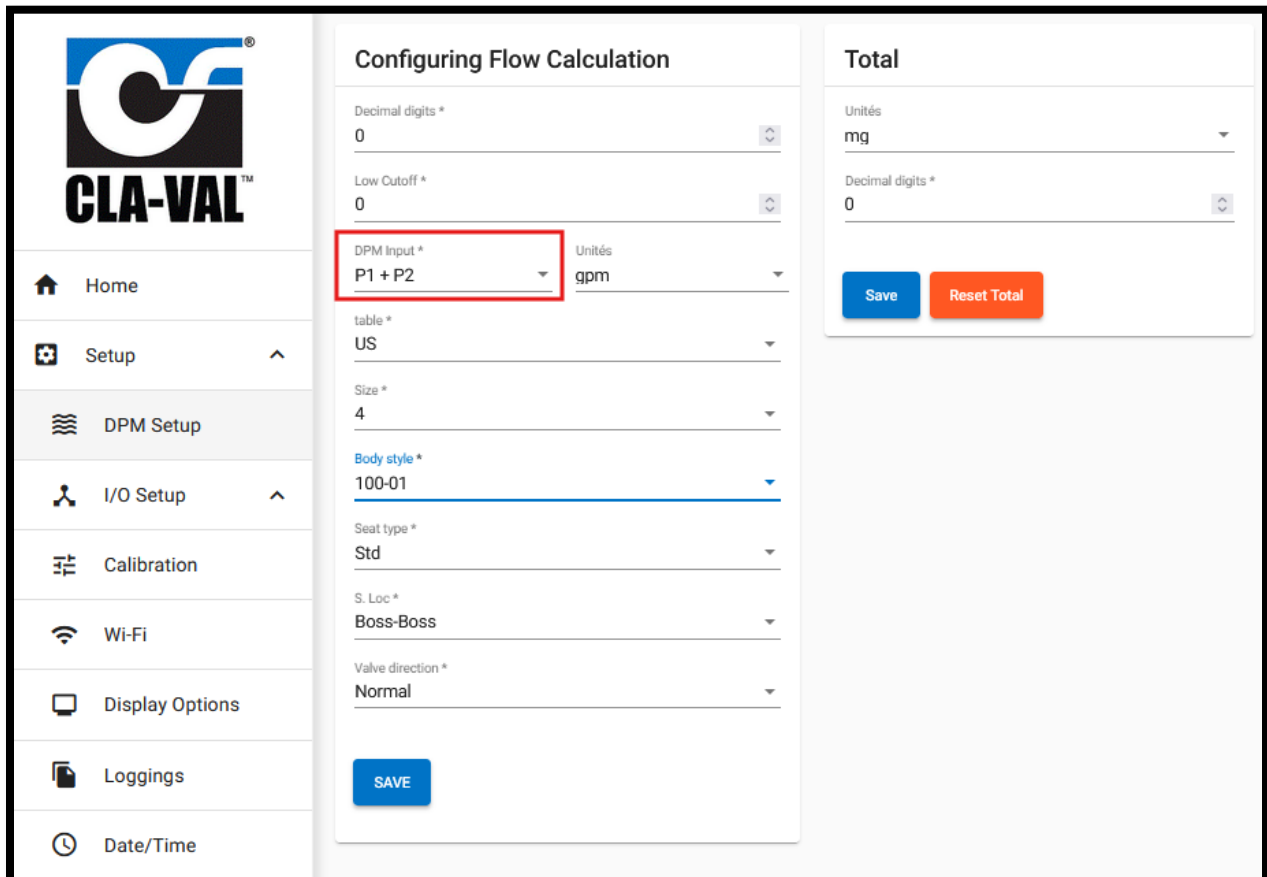

4.4.8.4 DPM Curve Adjust

To access the DPM Curve adjust settings, access to advanced mode is necessary using the icon in the top right corner of the web configuration page.

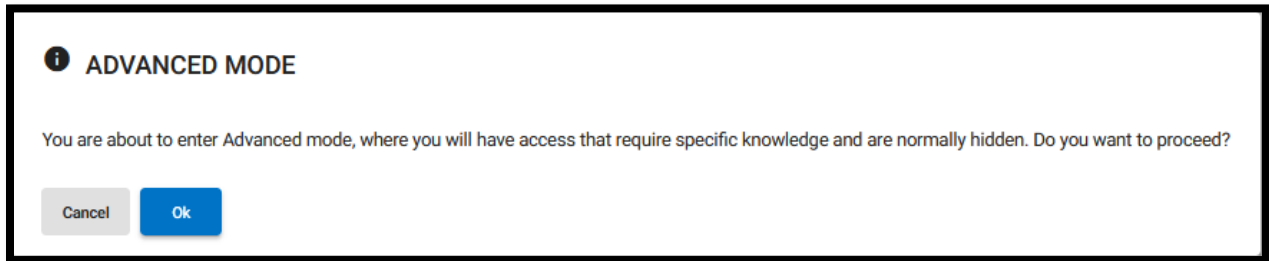
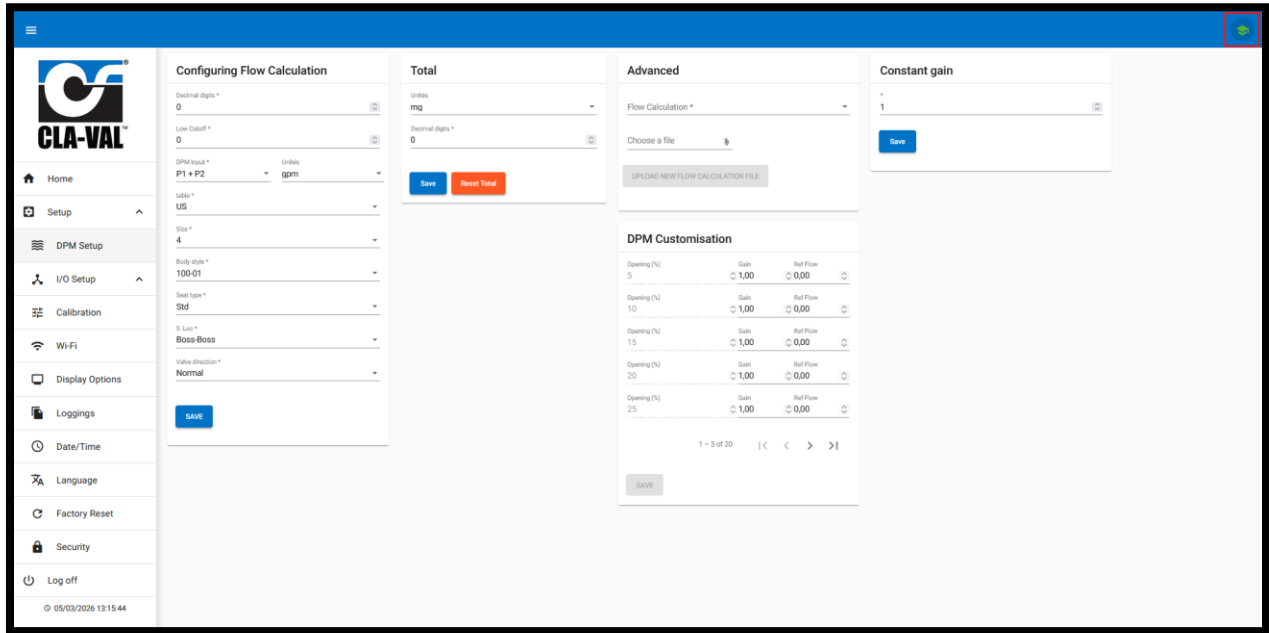

4.4.8.4.1 Constant Gain

**Description:** Multiplies the calculated flow through the valve by a user entered constant gain factor. This is used to remove a discrepancy between X35 and another flow meter. It's best to use the constant gain factor when there is a consistent percentage difference between the flow meter and the X35 regardless of valve position.

### Constant gain

---

\*  
1 ↕

---

Save

4.4.8.4.2 Custom DPM Table

**Description:** Multiplies the calculated flow through the valve by a user entered constant factor. The user can enter different gain factors for specific valve positions. This is used to remove a discrepancy between X35 and another flow meter when the discrepancy varies as the valve opens more.

### DPM Customisation

Opening (%)	Gain	Ref Flow	
5	↕ 1,00	↕ 0,00	↕
<hr style="border-top: 1px dashed #ccc;"/>			
10	↕ 1,00	↕ 0,00	↕
<hr style="border-top: 1px dashed #ccc;"/>			
15	↕ 1,00	↕ 0,00	↕
<hr style="border-top: 1px dashed #ccc;"/>			
20	↕ 1,00	↕ 0,00	↕
<hr style="border-top: 1px dashed #ccc;"/>			
25	↕ 1,00	↕ 0,00	↕

1 - 5 of 20    |<   <   >   >|

SAVE

4.4.9 I/O Setup

**Description:** Lists all input channels to X35 and the flow output channel. If an input channel is selected (Inlet Pressure, Outlet Pressure, Position, or Spare), then the input setup screen is displayed. If the flow output channel is selected, then the retransmission setup screen is displayed

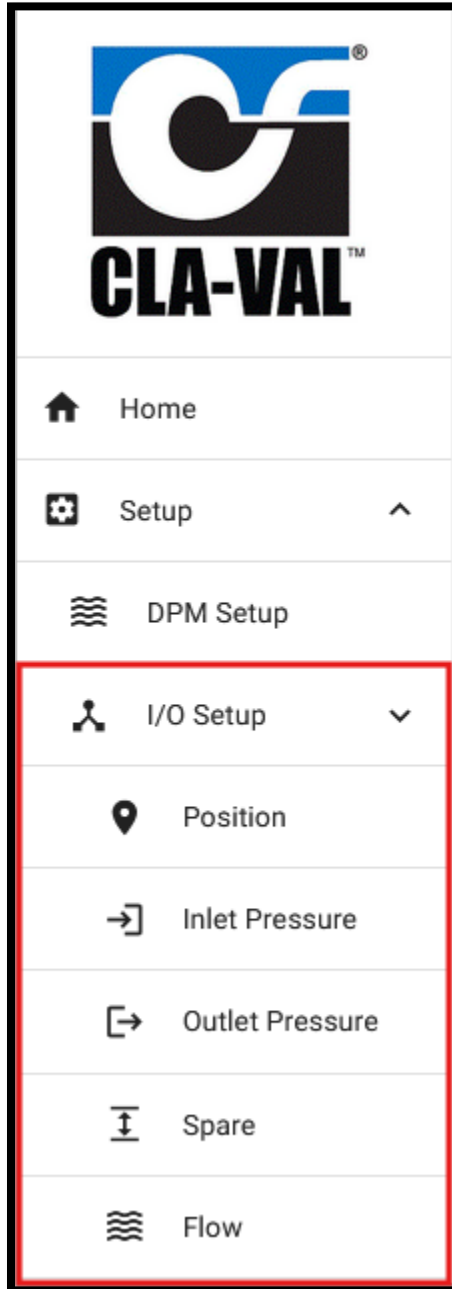

### Position

DPM Input \*  
AI1 (AI1) AI1 (4-20 mA)

**AI1**  7,198 mA **20,0 %**

Unités  
%

Decimal digits \*  
1

Measurement min (%) \*  
0

Measurement max (%)  
100

Filter coefficient \*  
0

SAVE CANCEL

### Retransmission

Retransmit to \*  
AO2 (AO2)

Min \*  
0

Max \*  
100

SAVE

---

### Channel Offset

Offset

Reported values  
19.98989486694336 %    7,2 mA

Targeted new value \*  
0

SAVE CANCEL

4.4.9.1 Input Configuration

### Position

DPM Input \*  
AI1 (AI1) AI1 (4-20 mA)

**AI1**  7,198 mA **20,0 %**

Unités  
%

Decimal digits \*  
1

Measurement min (%) \*  
0

Measurement max (%)  
100

Filter coefficient \*  
0

SAVE CANCEL

#### 4.4.9.2 Signal Retransmission

The Retransmission page shown below allows the signal received from the transmitter to be retransmitted via a 4-20mA output channel on the X35 to a PLC/SCADA system.

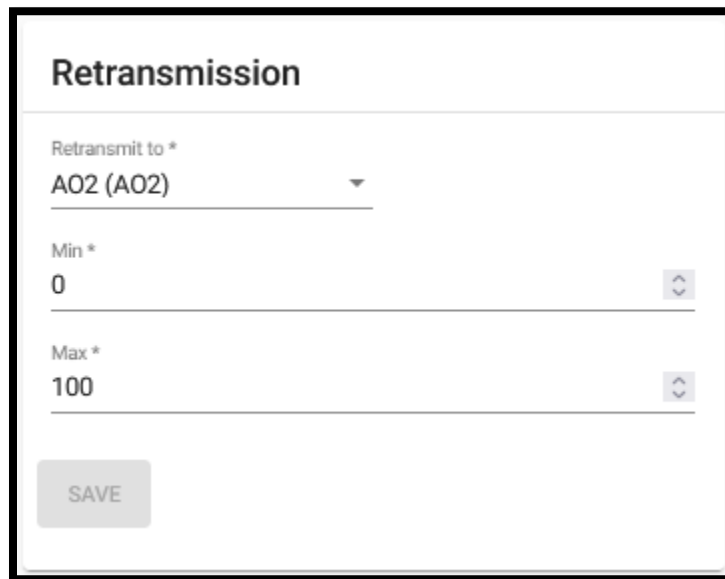

The screenshot shows the 'Retransmission' configuration page. It features a title 'Retransmission' at the top. Below the title, there is a dropdown menu labeled 'Retransmit to \*' with the selected option 'AO2 (AO2)'. Underneath, there are two input fields: 'Min \*' with the value '0' and 'Max \*' with the value '100'. Each input field has a small up/down arrow icon to its right. At the bottom left of the page, there is a grey 'SAVE' button.

#### 4.4.9.3 Channel Offset

The Channel Offset page allows the engineering value from the input to be increased or decreased by a fixed amount. For example, if the currently measured value is 5 psi but a mechanical gauge indicates it should be 7 psi, a targeted new value of 7 psi may be entered which will offset the measured value by 2 psi from now on.

**\*\*Note: channel offset configuration requires advanced mode, refer to section 5.1.1.1 for more information.**

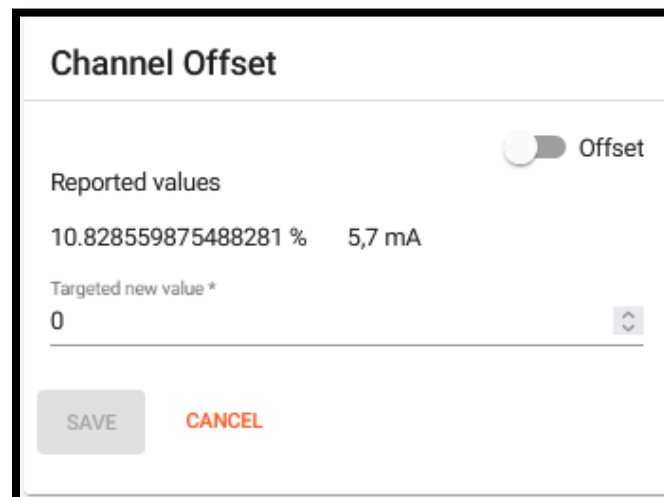

The screenshot shows the 'Channel Offset' configuration page. It features a title 'Channel Offset' at the top. Below the title, there is a toggle switch labeled 'Offset' which is currently turned off. Underneath, there is a section labeled 'Reported values' showing '10.828559875488281 %' and '5,7 mA'. Below that, there is an input field labeled 'Targeted new value \*' with the value '0' and a small up/down arrow icon to its right. At the bottom left, there is a grey 'SAVE' button, and at the bottom center, there is a red 'CANCEL' button.

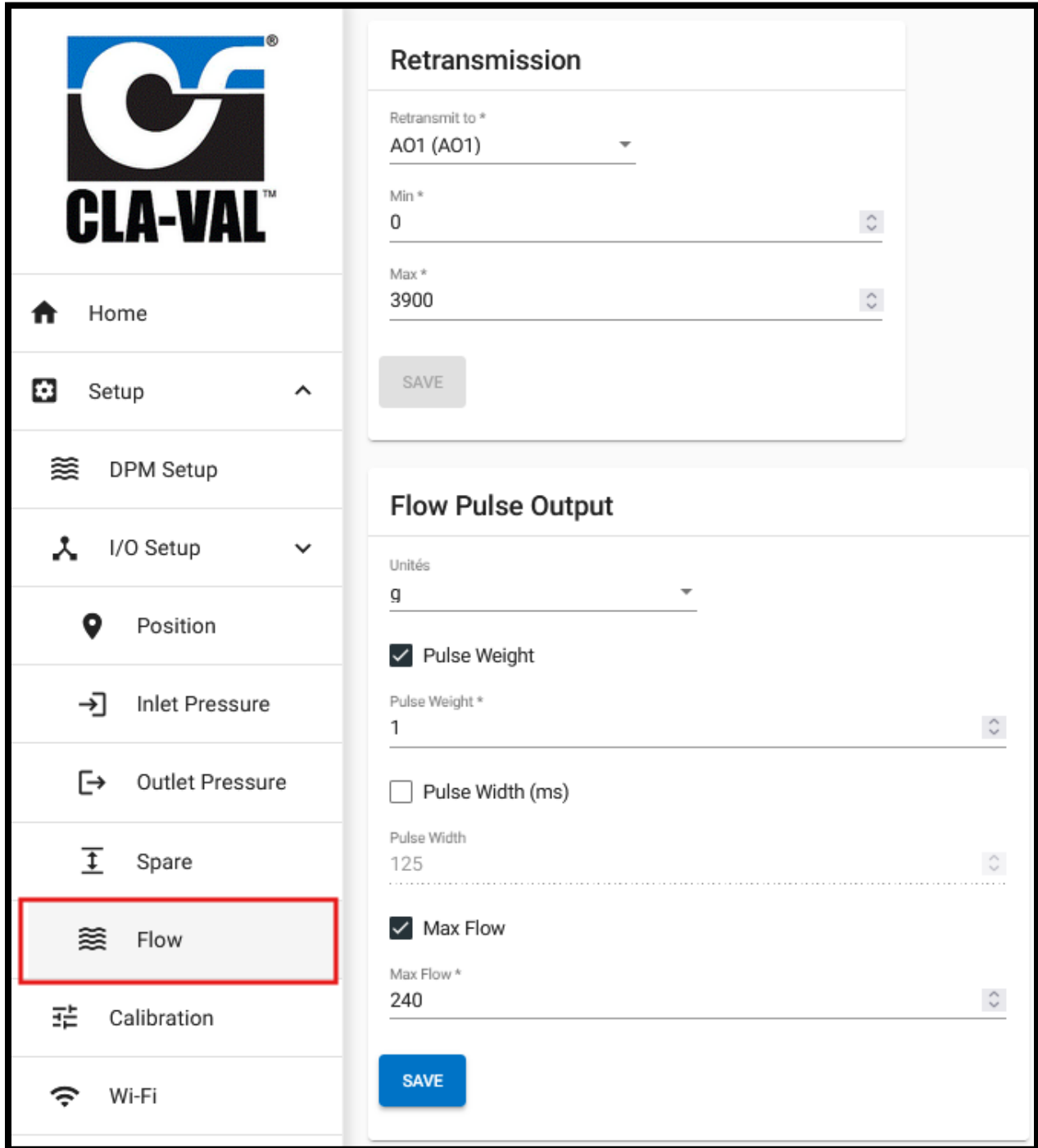

The screenshot displays the CLA-VAL web interface. On the left is a navigation sidebar with the following items: Home, Setup, DPM Setup, I/O Setup, Position, Inlet Pressure, Outlet Pressure, Spare, **Flow** (highlighted with a red box), Calibration, and Wi-Fi. The main content area is divided into two sections:

- Retransmission**:
  - Retransmit to \*: A01 (A01)
  - Min \*: 0
  - Max \*: 3900
  - A grey **SAVE** button is located at the bottom of this section.
- Flow Pulse Output**:
  - Unités: g
  - Pulse Weight
    - Pulse Weight \*: 1
  - Pulse Width (ms)
    - Pulse Width: 125
  - Max Flow
    - Max Flow \*: 240
  - A blue **SAVE** button is located at the bottom of this section.

4.4.9.4.1 Flow Retransmission

Flow retransmission allows for the transmission of the calculated flow value from X35 module to any available output, the default of flow retransmission is AO1 and no scaling of the output as every valve size is different in scaling, setting up the scaling is essential for mA generation through analog output.

### Retransmission

Retransmit to \*  
 AO1 (AO1) ▼

Min \*  
 0

Max \*  
 0

SAVE

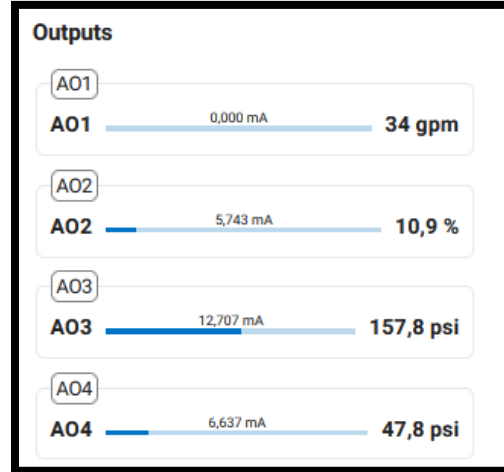

### Retransmission

Retransmit to \*  
 AO1 (AO1) ▼

Min \*  
 0

Max \*  
 100

SAVE

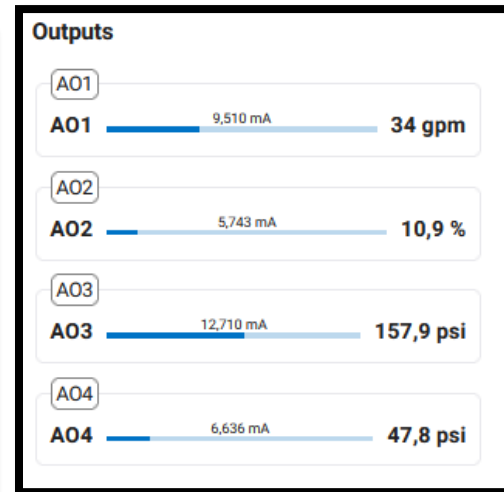

4.4.9.4.2 Flow Pulse Output

The totalizer digital output allows the configuration of parameters which are generated as pulses sent to an input card of a PLC, RTU, etc.

### Flow Pulse Output

Unités  
g

Pulse Weight  
Pulse Weight \*  
1

Pulse Width (ms)  
Pulse Width  
125

Max Flow  
Max Flow \*  
240

SAVE

4.4.10 Calibration



4.4.10.1 Input Calibration

**Description:** Used when the milliamps/volts measured on an input channel on the X35 differ from the value measured on a multimeter or PLC/SCADA system. Allows the discrepancy to be eliminated.

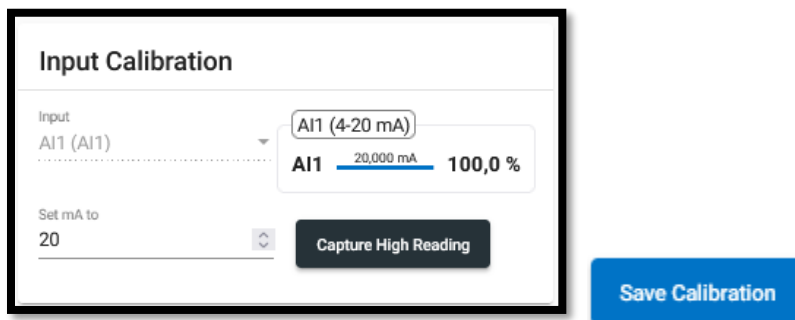
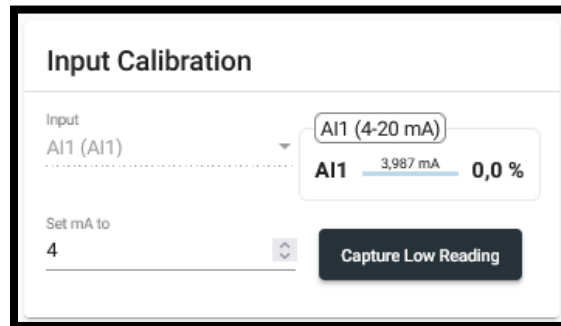

4.4.10.2 Output Calibration

**Output Calibration**

Output \*  
A01 (A01) ▼

**START CALIBRATION**

**Output Calibration**

Output  
A01 (A01) ▼

The device is now outputting 5mA. Please enter the reading.

5mA Reading  
4.98 ▼

**CONFIRM 5mA READING**

**Output Calibration**

Output  
A01 (A01) ▼

The device is now outputting 19mA. Please enter the reading.

19mA Reading  
19 ▼

**CONFIRM 19mA READING**

**Output Calibration**

Output  
A01 (A01) ▼

**SAVE CALIBRATION**

4.4.11 Wi-Fi settings

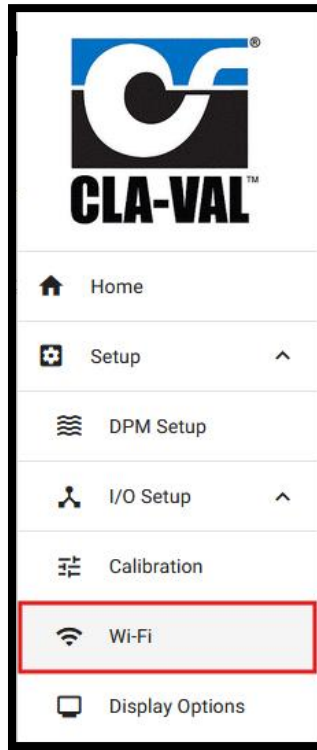

**WiFi access point**

Enabled

WiFi network name (SSID) \*  
X35\_211123085

Current Password  
.....

Password \*  
.....

Confirm Password \*  
.....

Passwords must match

SAVE

**WiFi Disable**

Disabling WiFi access point will result in losing communication with X35 module.

YES NO

4.4.12 Display Options

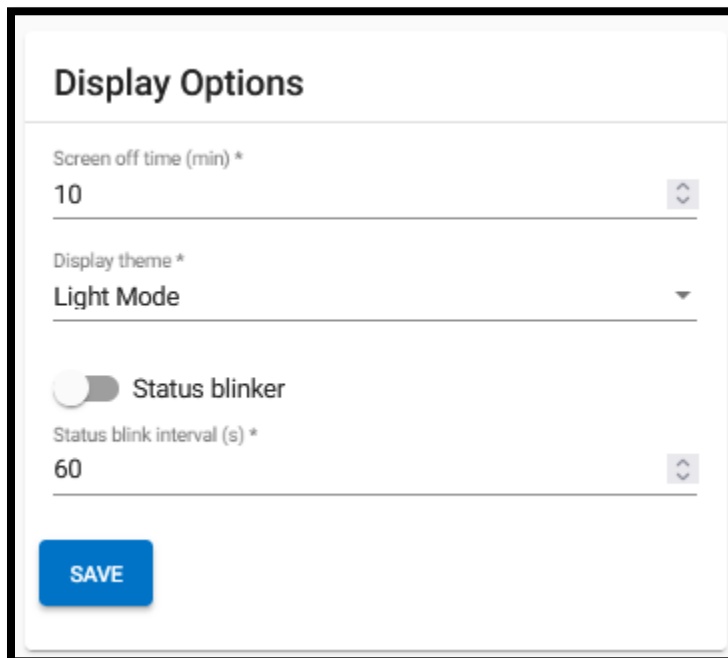
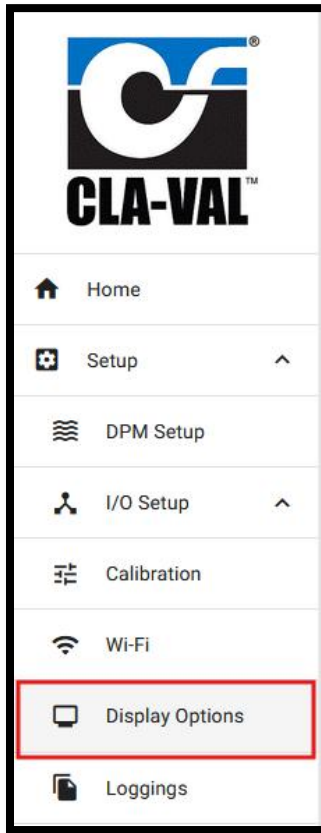

4.4.13 Loggings

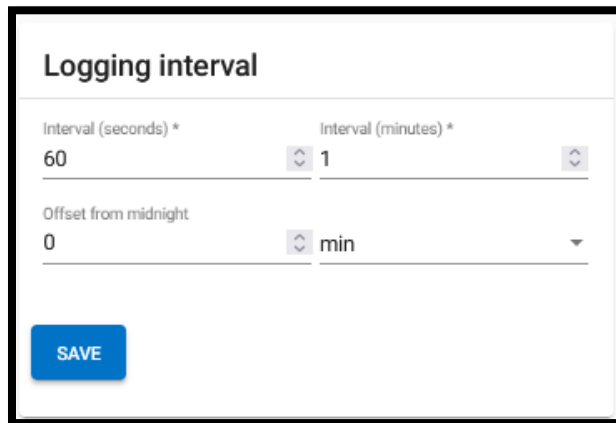
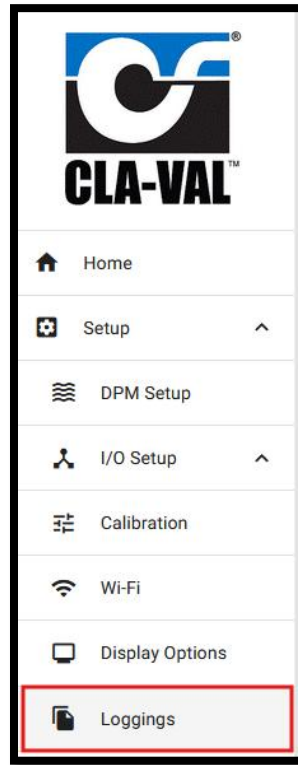

4.4.14 Date/Time

**Description:** Used to set current date and time. Date and time formats can also be changed.

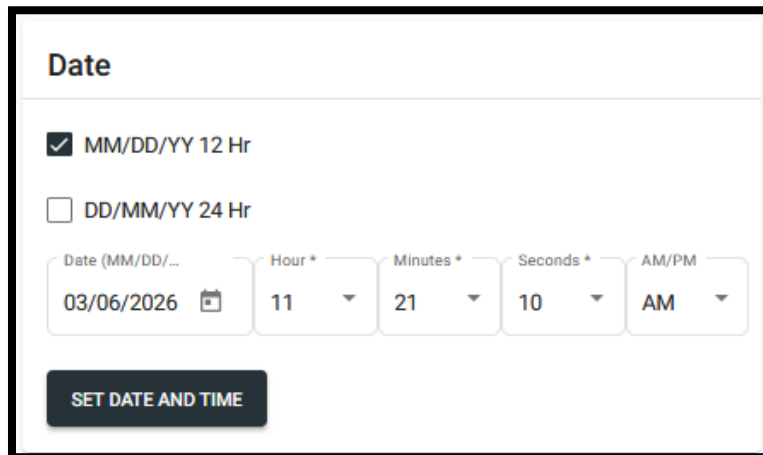
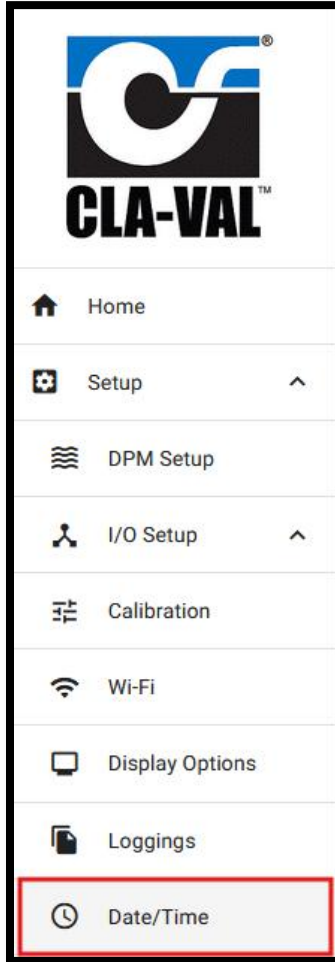

4.4.15 Language

**Description:** Used to change the language on X35 display to one of the supported languages by the module.

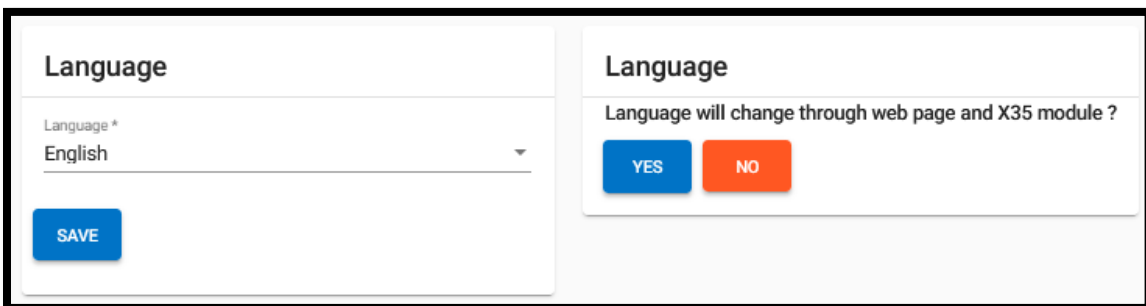
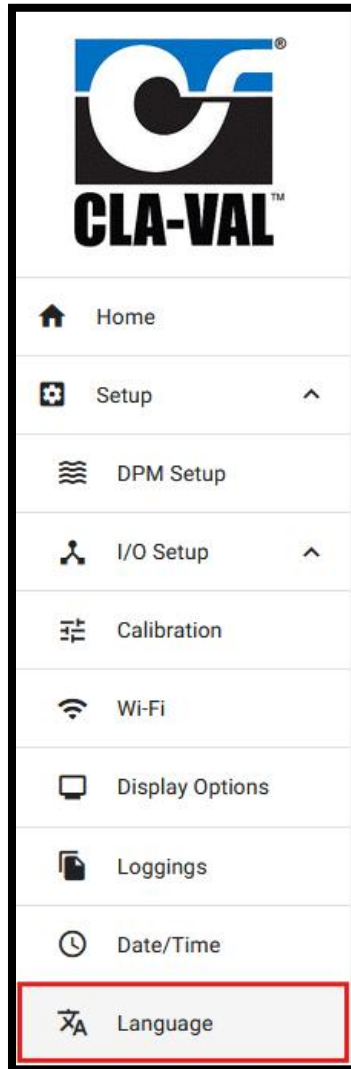

#### 4.4.16 Factory Reset

**Description:** used to reset all settings back to factory defaults, this includes the SSID WI-FI network and password.

**\*\*Note:** refer to section 4.4.7 for default WIFI SSID and password in the case of a factory reset.

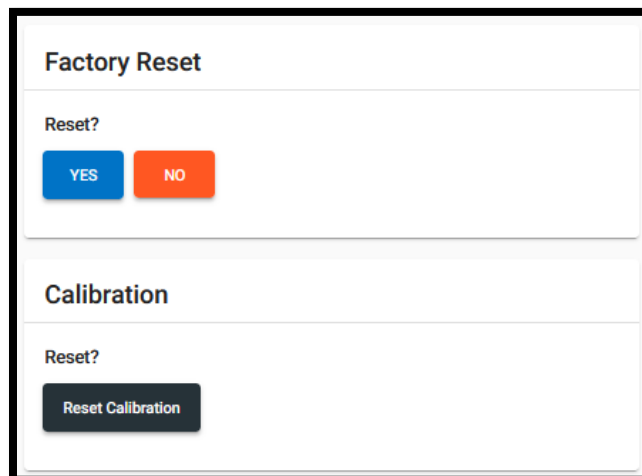
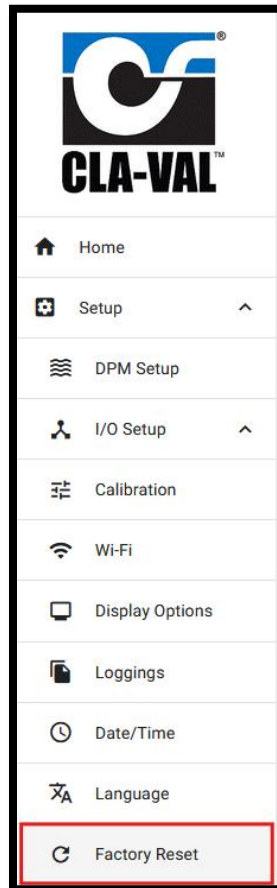

4.4.17 Security

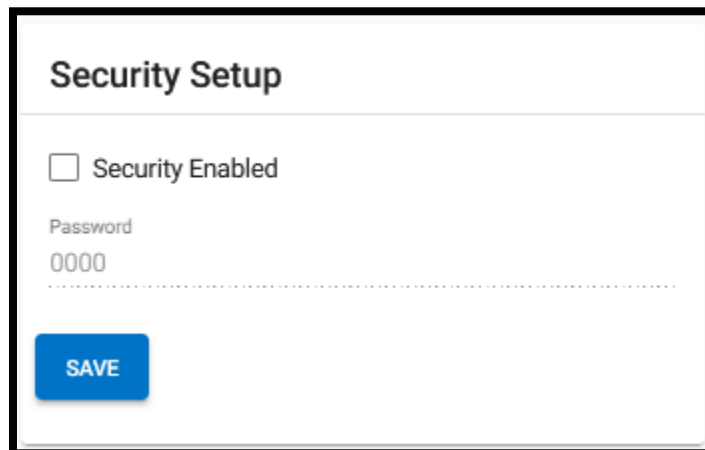
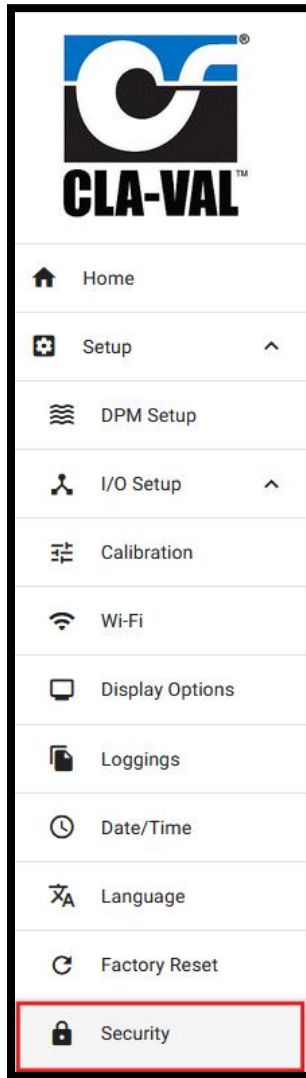

**Security Setup**

Security Enabled

Password  
0000

.....

**SAVE**

SD Card Features section. **DO NOT remove the SD card unless the X35 is powered down! Doing so may corrupt all the data on the SD card.**

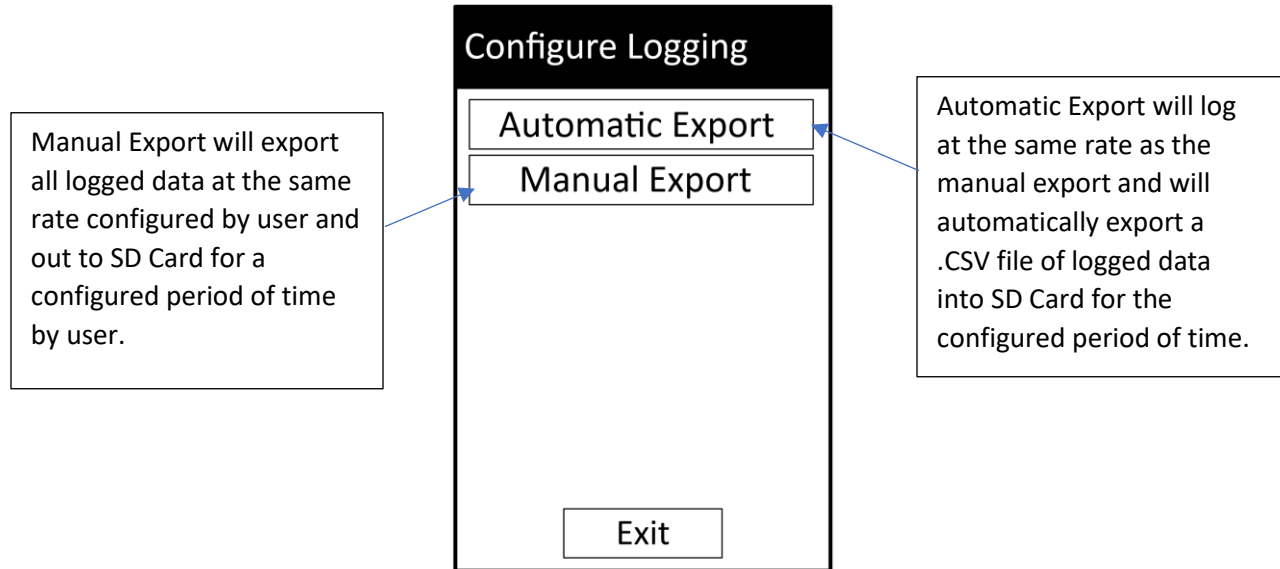

Figure 4.32

4.4.17.1 Automatic Export

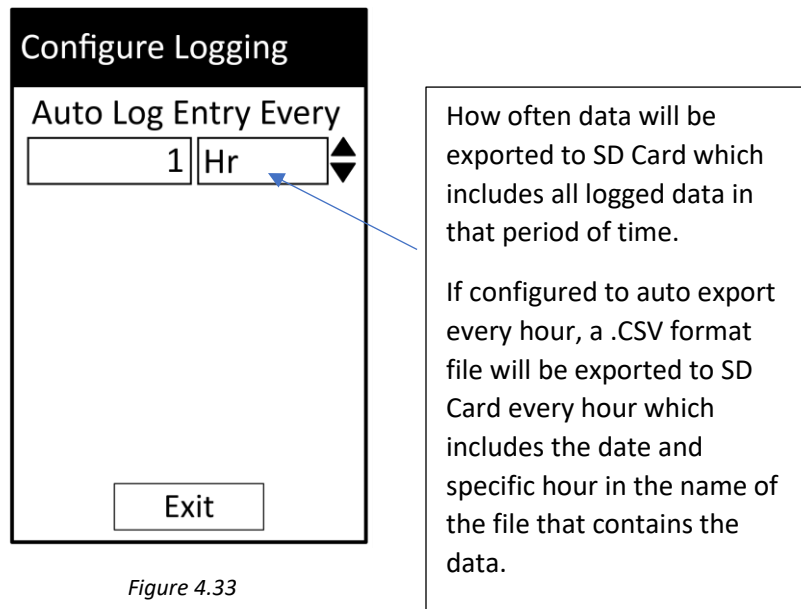

Figure 4.33

4.4.17.2 Manual Export

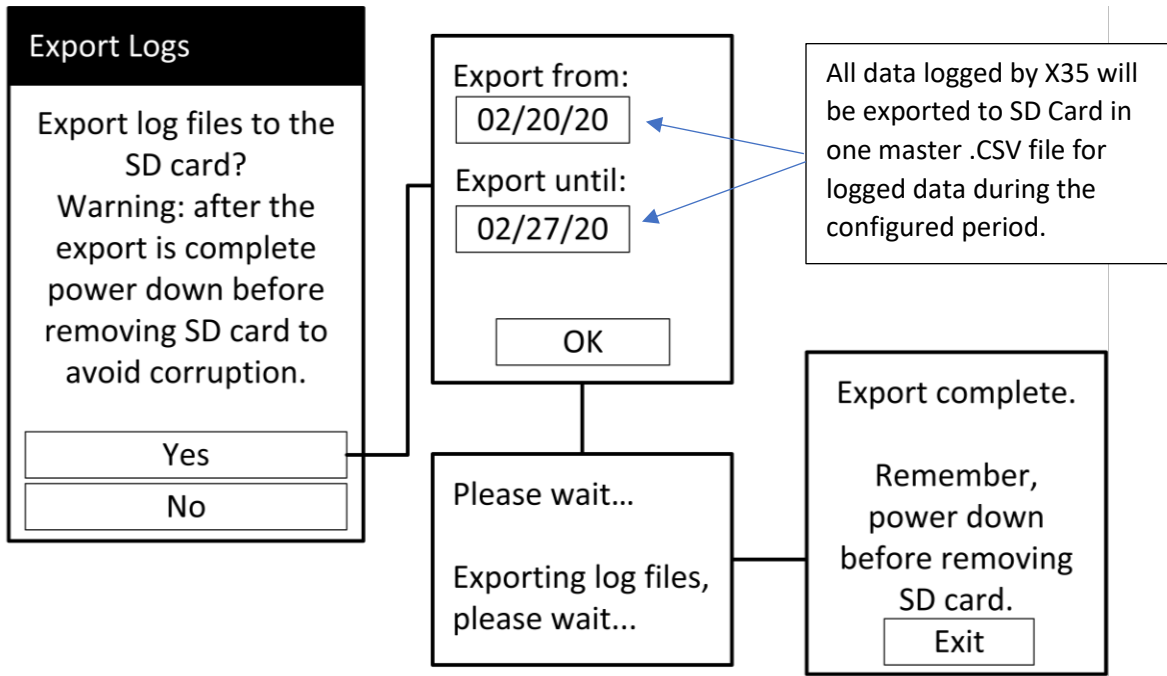

Figure 4.34

#### 4.4.18 WI-FI

**Description:** Used to enable/disable, view the WI-FI information required for connecting to X35.

The WI-FI tab displays the required information and settings to enable/disable the WI-FI configuration access to X35 module, in addition to that it displays the WIFI (SSID) along with the password which is protected information via enabling the security options in section 4.4.11, and the IP address associated with the device for connection.

**\*\*Note:** Refer to section 5 for a full X35 WI-FI configuration setup.

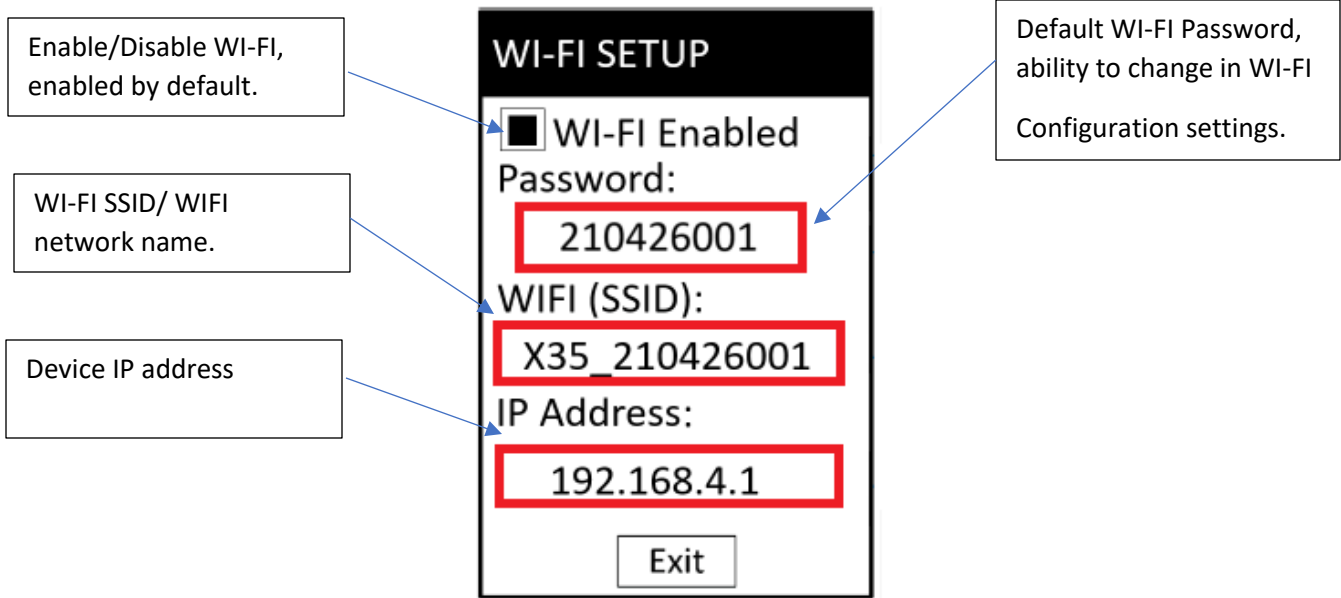

Figure 4.35

to connect to X35 module a WIFI communication device is required, **throughout this user manual a computer is used to preview all settings and menu structures**, note that other devices can be used such as a mobile phone or a tablet device.

#### 4.4.19 Date/Time

**Description:** Used to set current date and time. Date and time formats can also be changed.

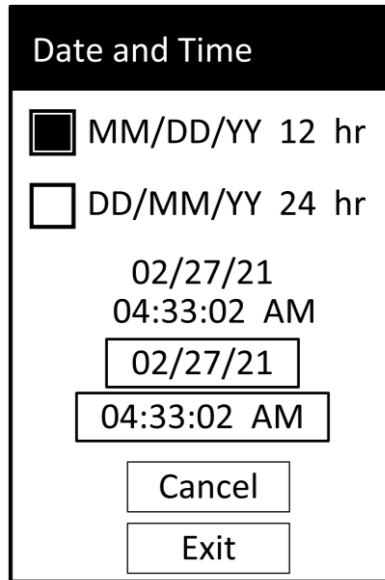

Figure 4.38

#### 4.4.20 Language

**Description:** Used to change the language displayed on the screen.

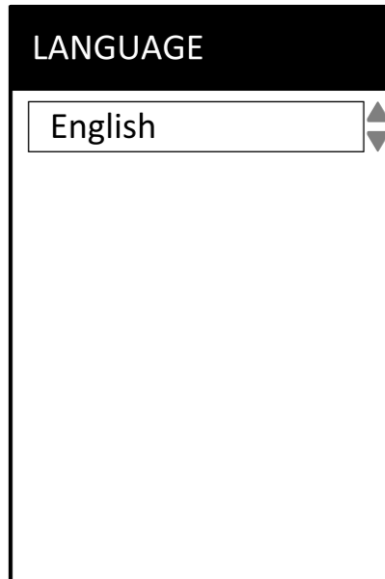

Figure 4.39

4.4.21 Factory Reset

**Description:** Used to reset all settings back to the factory default settings.

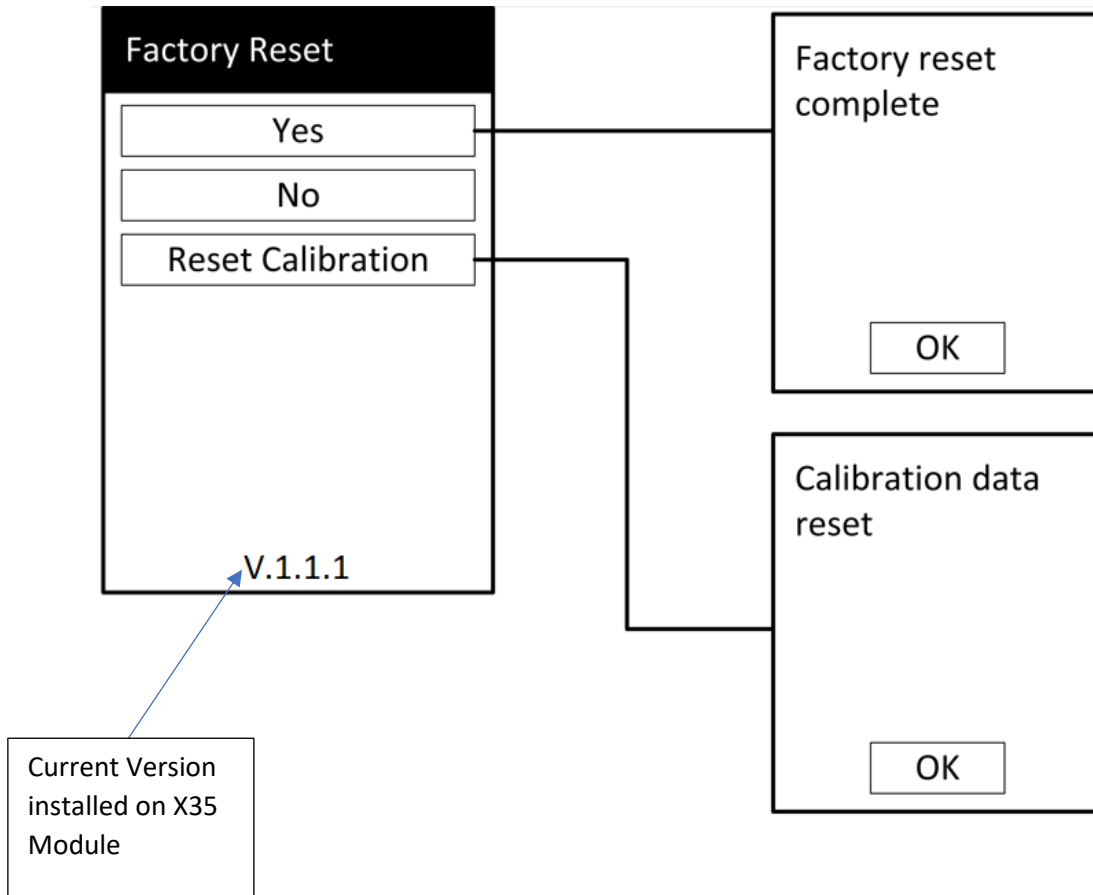

Figure 4.40

4.4.22 Security

**Description:** Used to add a security password to protect access to any critical settings withing the X35 module.

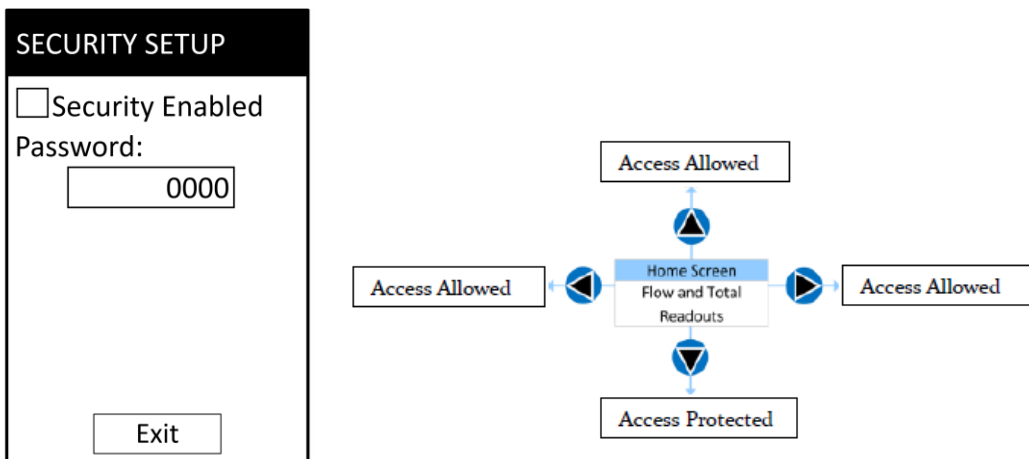

Figure 4.41

## 4.5 WI-FI Configuration Setup

### 4.5.1.1 Initial WI-FI Configuration

To connect to X35, access to the WI-FI setup page is discussed in the previous section and open WI-FI settings using a computer, mobile phone, etc.

The WI-FI information is displayed in the WI-FI setup page on the X35 display along with the IP address to connect to.

**\*\*Note: Refer to section 4.4.18 for WI-FI settings and information in X35 display.**

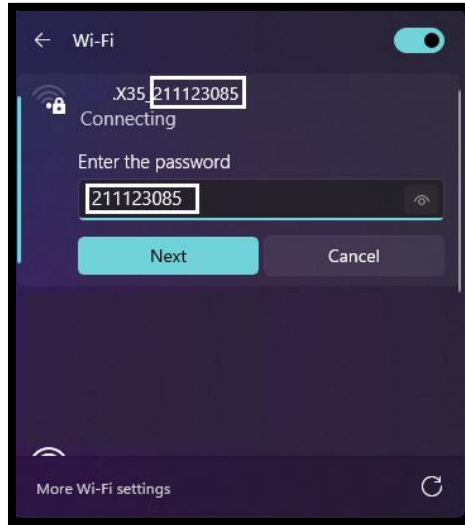

Figure 4.36

After successfully connecting to X35 WI-FI network, open a browser and type in the IP address 192.168.4.1 and click enter, WI-FI configuration setup should open and display as figure below:

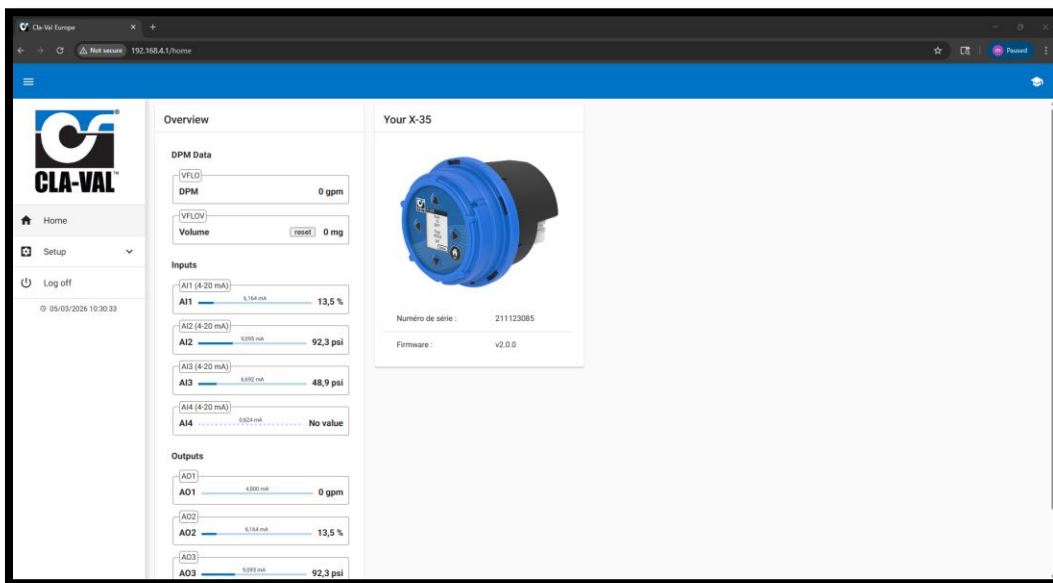

Figure 4.37

**\*\*Note: If unable to access the IP address using a browser, make sure proxy settings are disabled from browser.**

### 4.5.2 WI-FI Setup

This section presents a complete X35 configuration setup using the WI-FI interface only and follows the same sequence as section 4.4, which uses X35 module display for configuration.

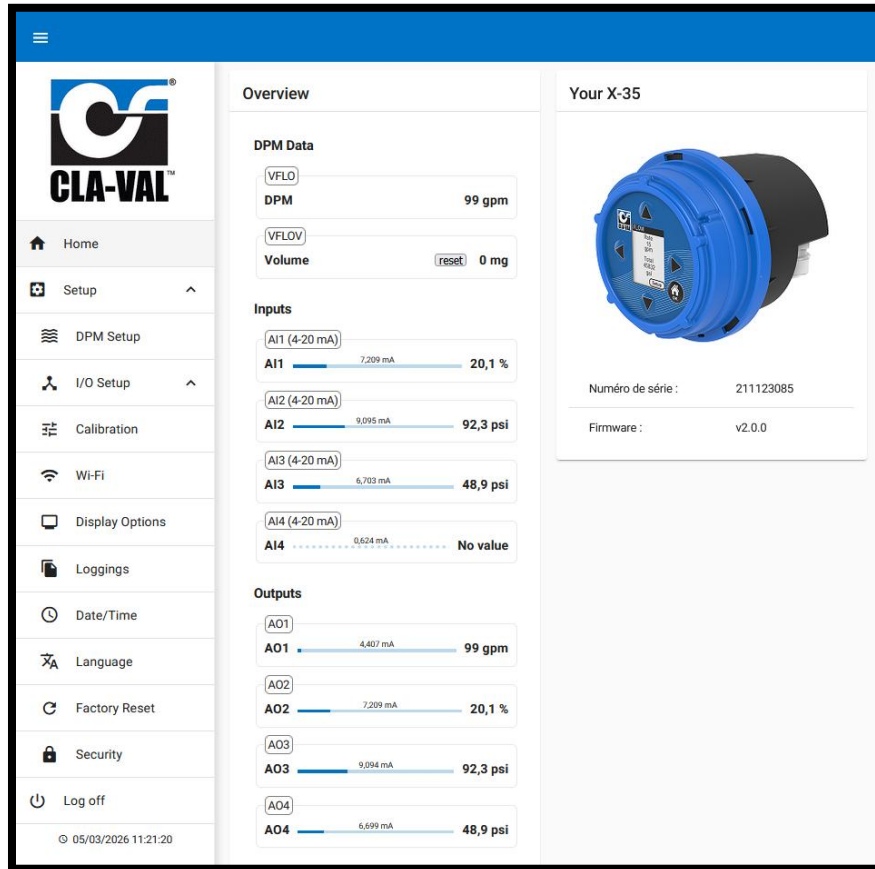

Figure 4.42

#### 4.5.2.1 Advanced Mode

Advanced mode in X35 displays other configuration menus that may be required for configuration setup.

To access advanced mode in WI-FI configuration page, navigate to the top right corner of the browser

page and click on the following symbol , confirm the access request from the displayed screen below.

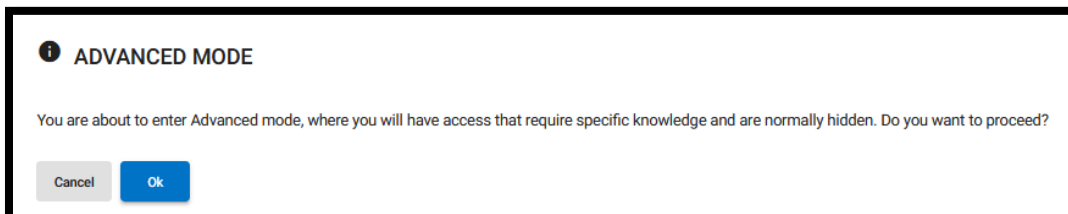

Figure 4.43

4.5.3 DPM Setup

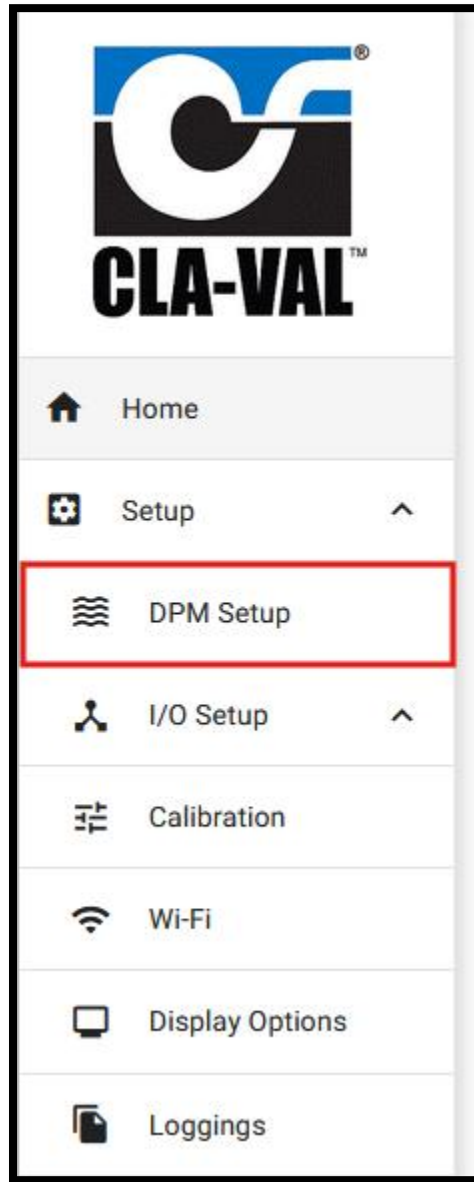
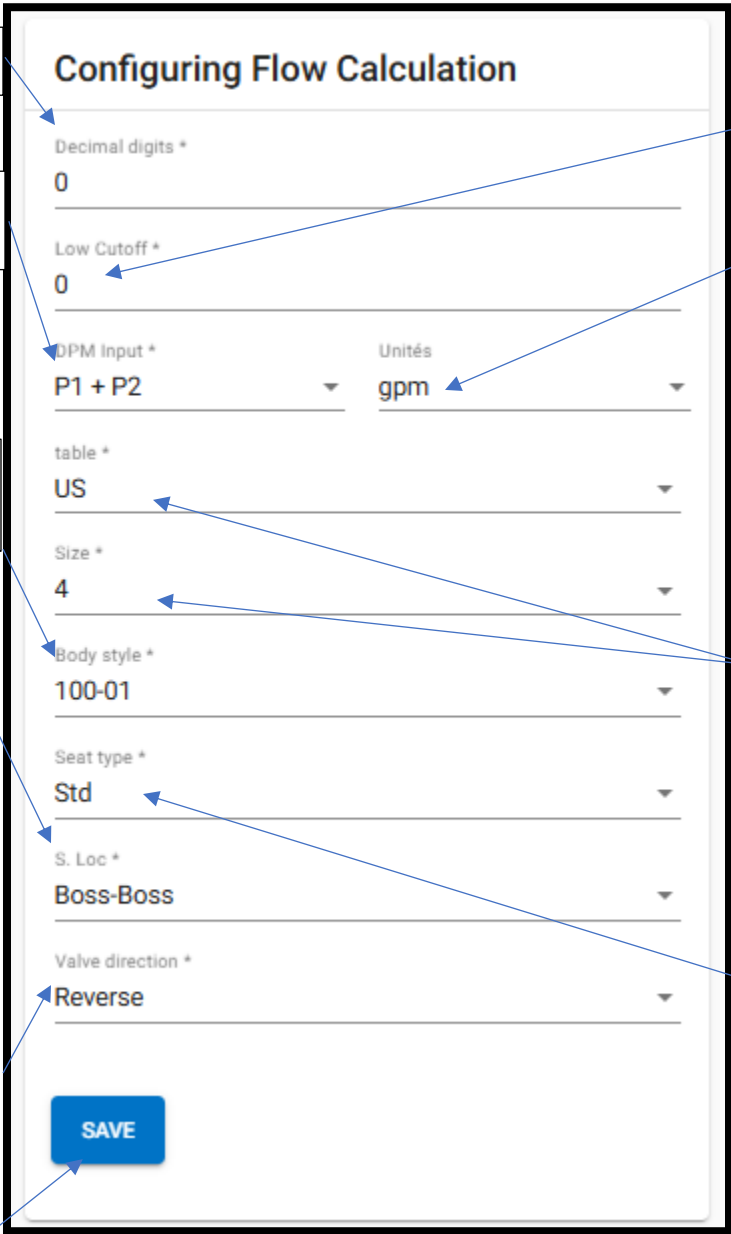

Figure 4.44

4.5.3.1 Valve

**Description:** Allows the user to tell the X35 specifics about the valve, pressure sensor locations, and flow direction that are needed so flow can be calculated.



**Configuring Flow Calculation**

- Decimal digits \*  
0
- Low Cutoff \*  
0
- DPM Input \*  
P1 + P2
- Unités  
gpm
- table \*  
US
- Size \*  
4
- Body style \*  
100-01
- Seat type \*  
Std
- S. Loc \*  
Boss-Boss
- Valve direction \*  
Reverse
- SAVE

**Callout Boxes:**

- Decimal accuracy of flow reading
- Inlet and outlet pressure transmitters or DPM transmitter
- Valve body type can be 100-01 (full port), 100-20 (reduced port)
- Location of pressure sensors. May be Boss-Boss (inlet and outlet ports) or Pipe-Pipe (upstream and downstream pipe)
- Flow direction is normal or reverse
- Save to apply changes
- Flow under the low cutoff will display as ZERO flow
- Calculated flow display units
- Valve size may be in US units (inches) or metric (mm)
- Seat type of valve may be Std (standard) or KO (anti-cav)

Figure 4.45

4.5.3.2 Total

**Description:** Allows the user to configure units for flow total, number of decimal points to display, and reset the flow total.



Figure 4.46

4.5.3.3 DPM Inputs

**Description:** Specifies if an upstream and downstream pressure transmitter is connected to the X35, or if differential pressure transmitter is connected to the X35.

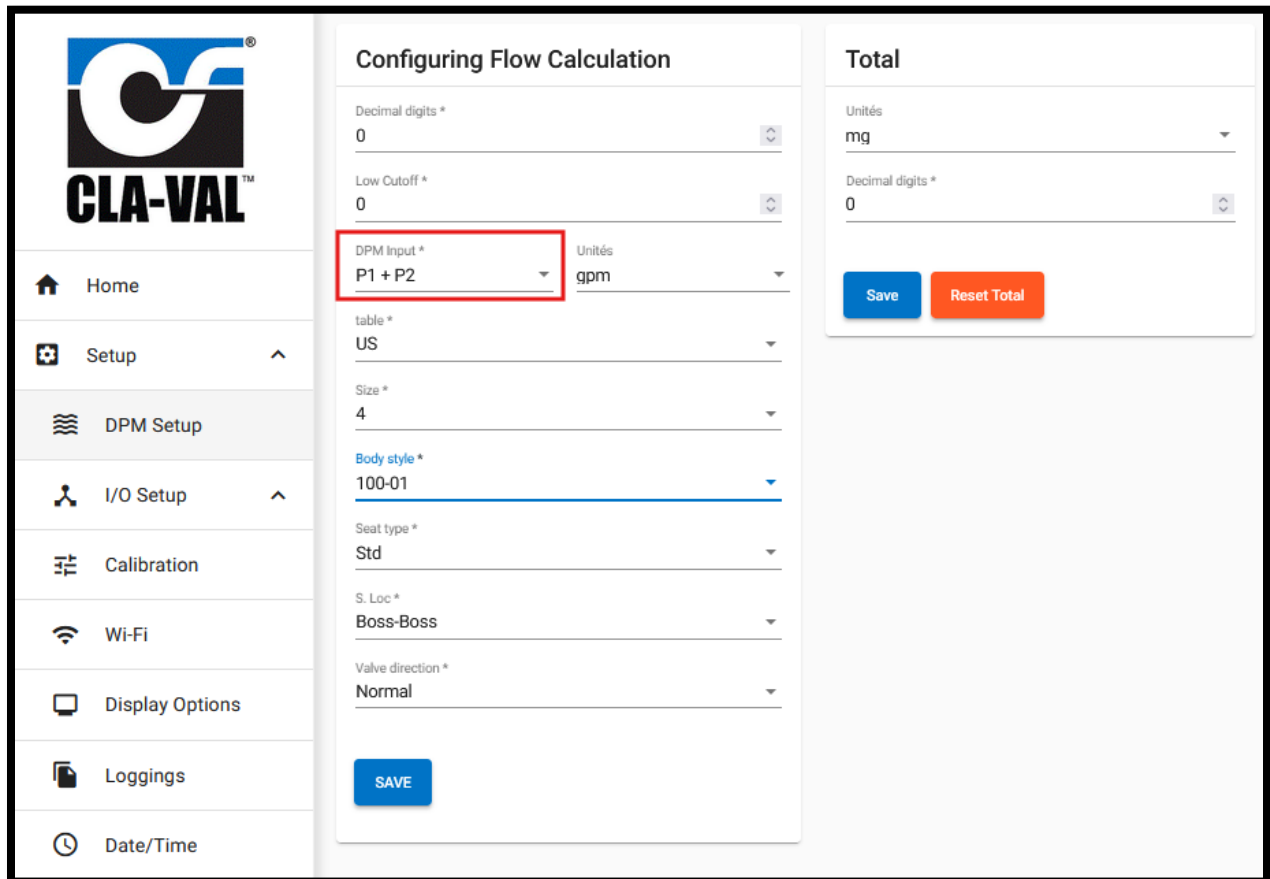

Figure 4.47

4.5.3.4 DPM Curve Adjust

To access the DPM Curve adjust settings, access to advanced mode is necessary using the icon in the top right corner of the web configuration page.

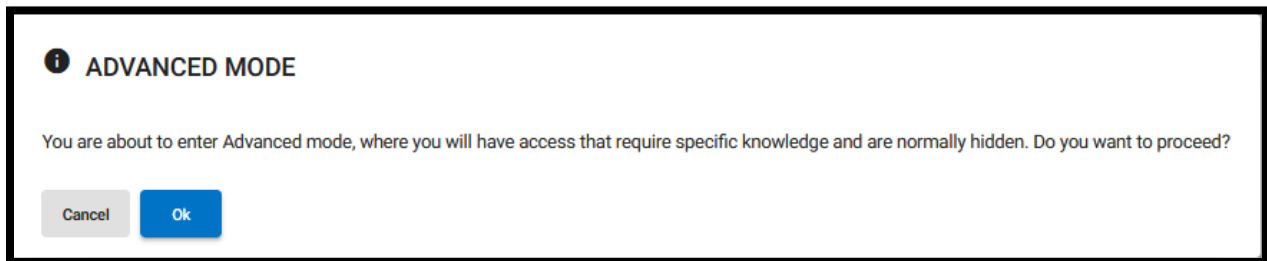
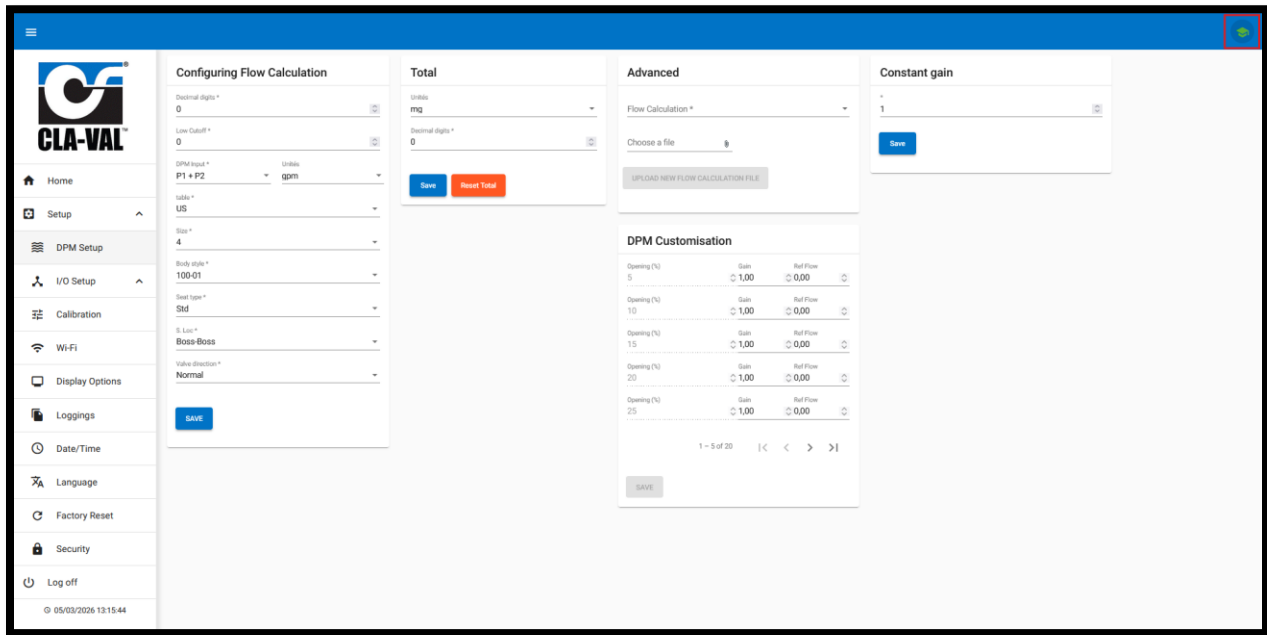

Figure 4.48

4.5.3.4.1 Constant Gain

**Description:** Multiplies the calculated flow through the valve by a user entered constant gain factor. This is used to remove a discrepancy between X35 and another flow meter. It's best to use the constant gain factor when there is a consistent percentage difference between the flow meter and the X35 regardless of valve position.

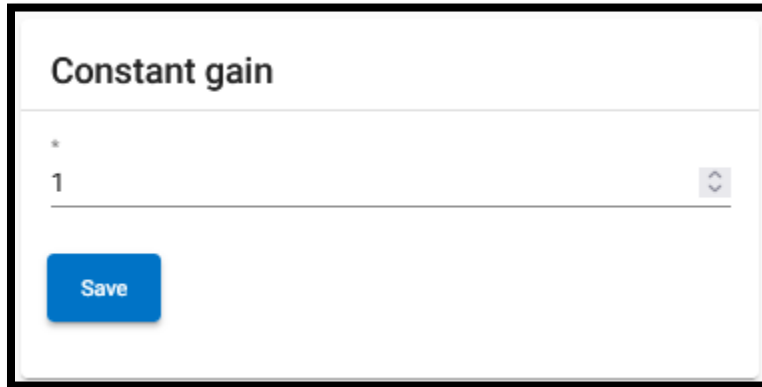
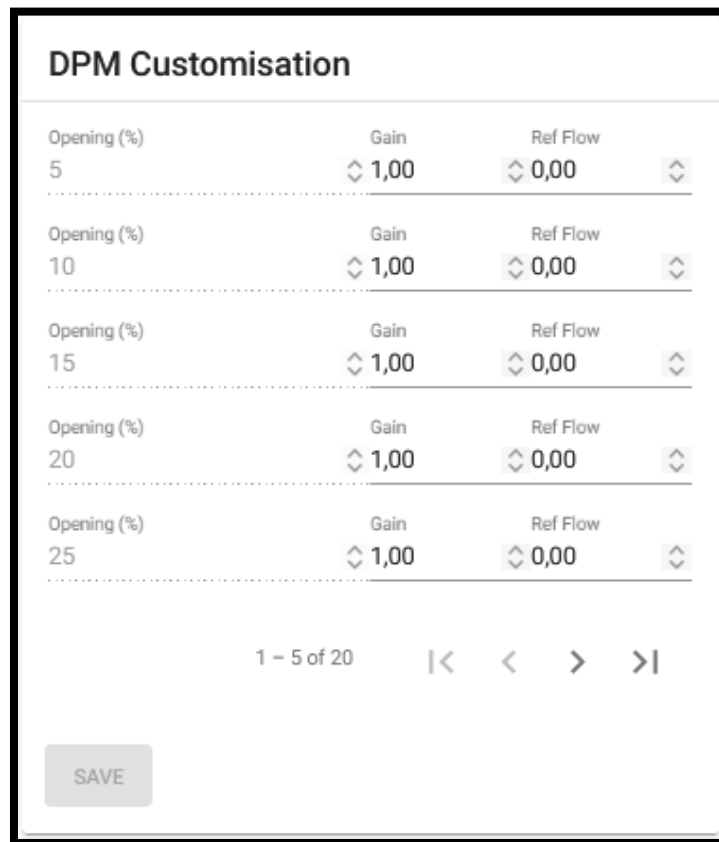

Figure 4.49

4.5.3.4.2 Custom DPM Table

**Description:** Multiplies the calculated flow through the valve by a user entered constant factor. The user can enter different gain factors for specific valve positions. This is used to remove a discrepancy between X35 and another flow meter when the discrepancy varies as the valve opens more.



Opening (%)	Gain	Ref Flow
5	1,00	0,00
10	1,00	0,00
15	1,00	0,00
20	1,00	0,00
25	1,00	0,00

Figure 4.50

4.5.4 I/O Setup

**Description:** Lists all input channels to X35 and the flow output channel. If an input channel is selected (Inlet Pressure, Outlet Pressure, Position, or Spare), then the input setup screen is displayed. If the flow output channel is selected, then the retransmission setup screen is displayed

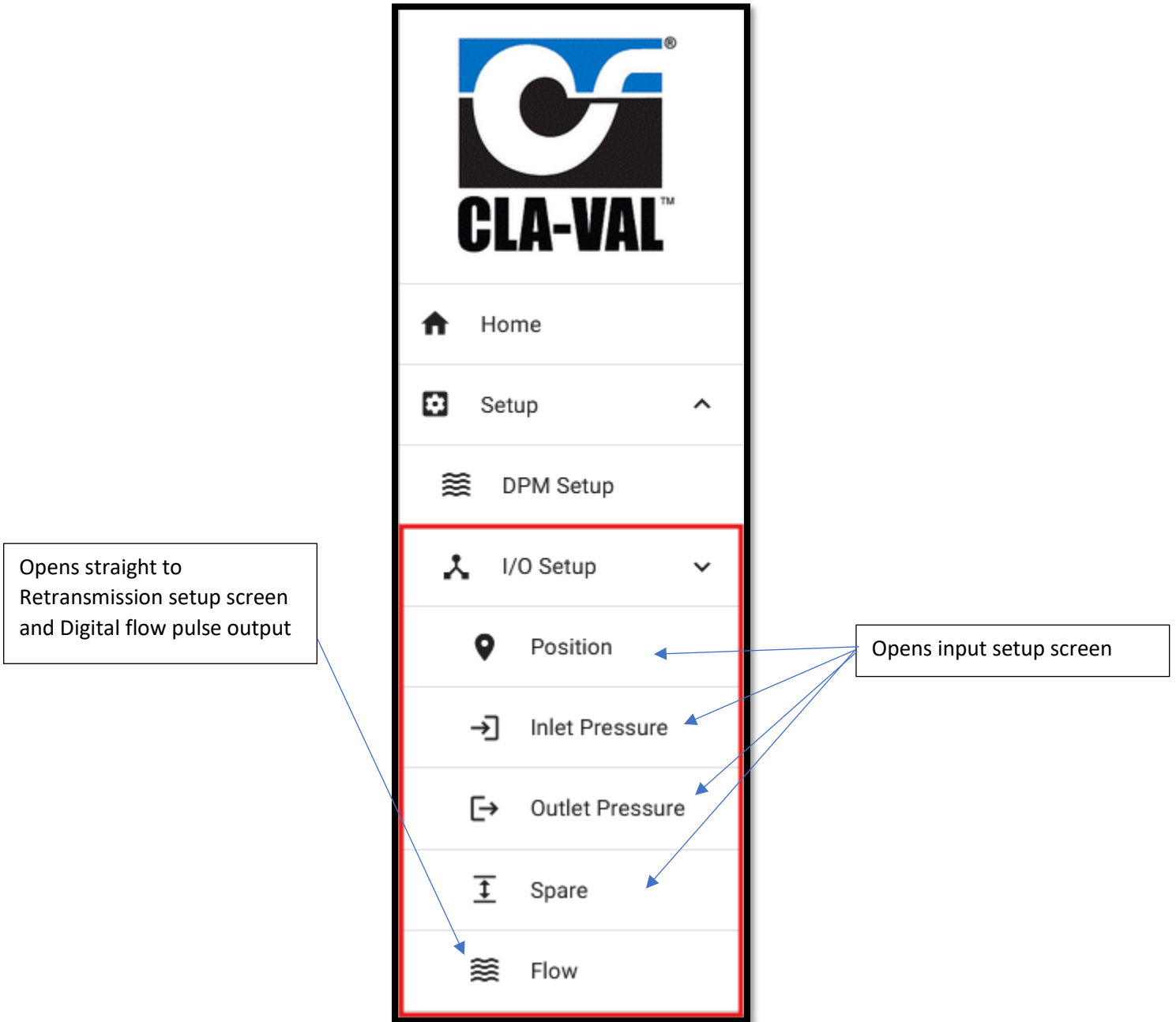

Figure 4.51

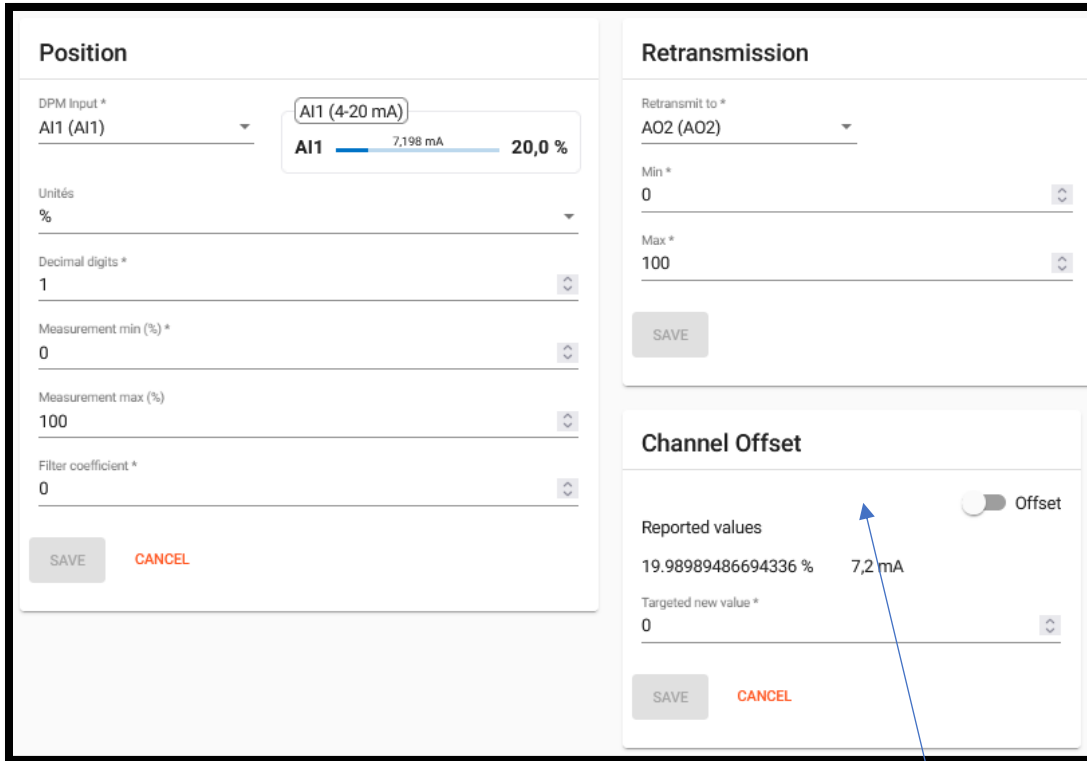

Figure 4.52

Requires Advanced Mode

4.5.4.1 Input Configuration

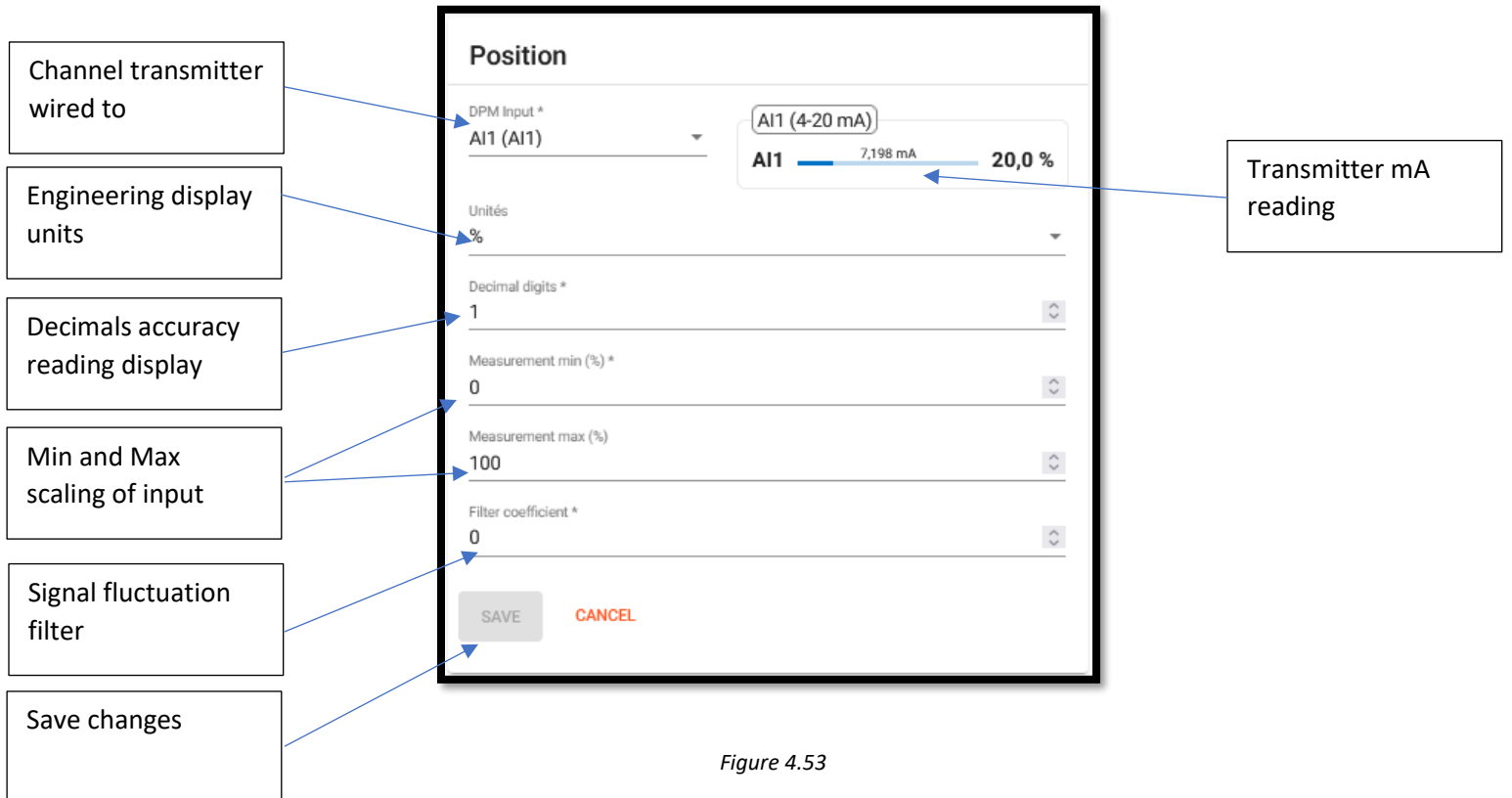
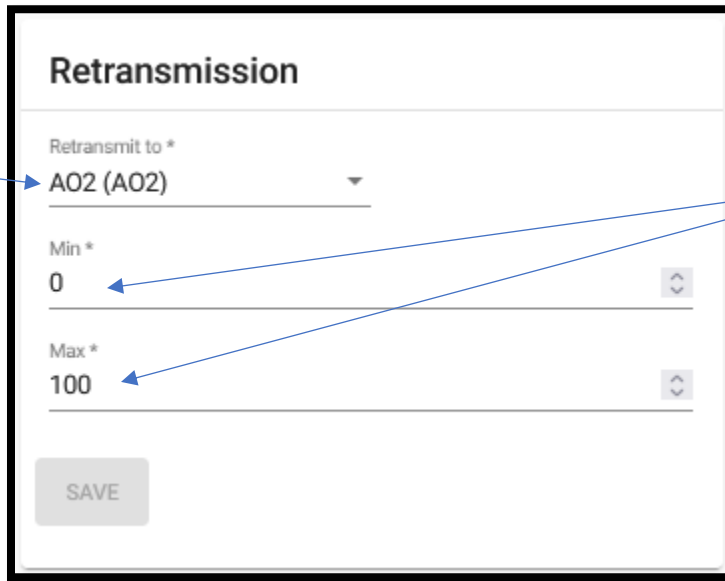

Figure 4.53

4.5.4.2 Signal Retransmission

The Retransmission page shown below allows the signal received from the transmitter to be retransmitted via a 4-20mA output channel on the X35 to a PLC/SCADA system.



The 4-20mA output channel the signal will be transmitted from

Min and Max scaling of the output

Figure 4.54

4.5.4.3 Channel Offset

The Channel Offset page allows the engineering value from the input to be increased or decreased by a fixed amount. For example, if the currently measured value is 5 psi but a mechanical gauge indicates it should be 7 psi, a targeted new value of 7 psi may be entered which will offset the measured value by 2 psi from now on.

**\*\*Note: channel offset configuration requires advanced mode, refer to section 5.1.1.1 for more information.**

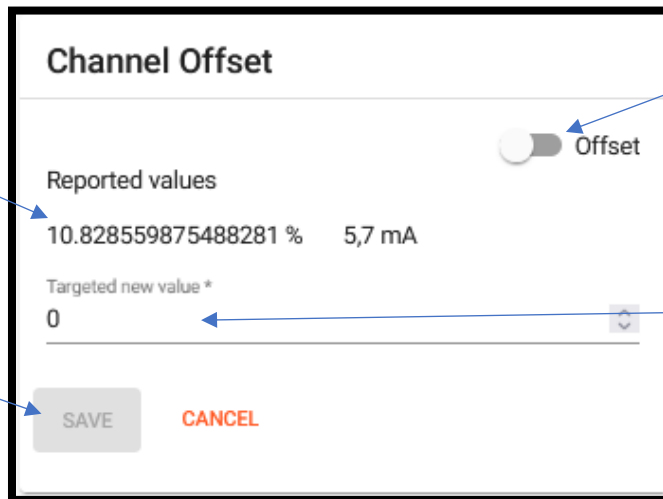

Current measured value from transmitter

Enable/disable channel offset

Save changes

New value to adjust the input

Figure 4.55

4.5.4.4 Flow

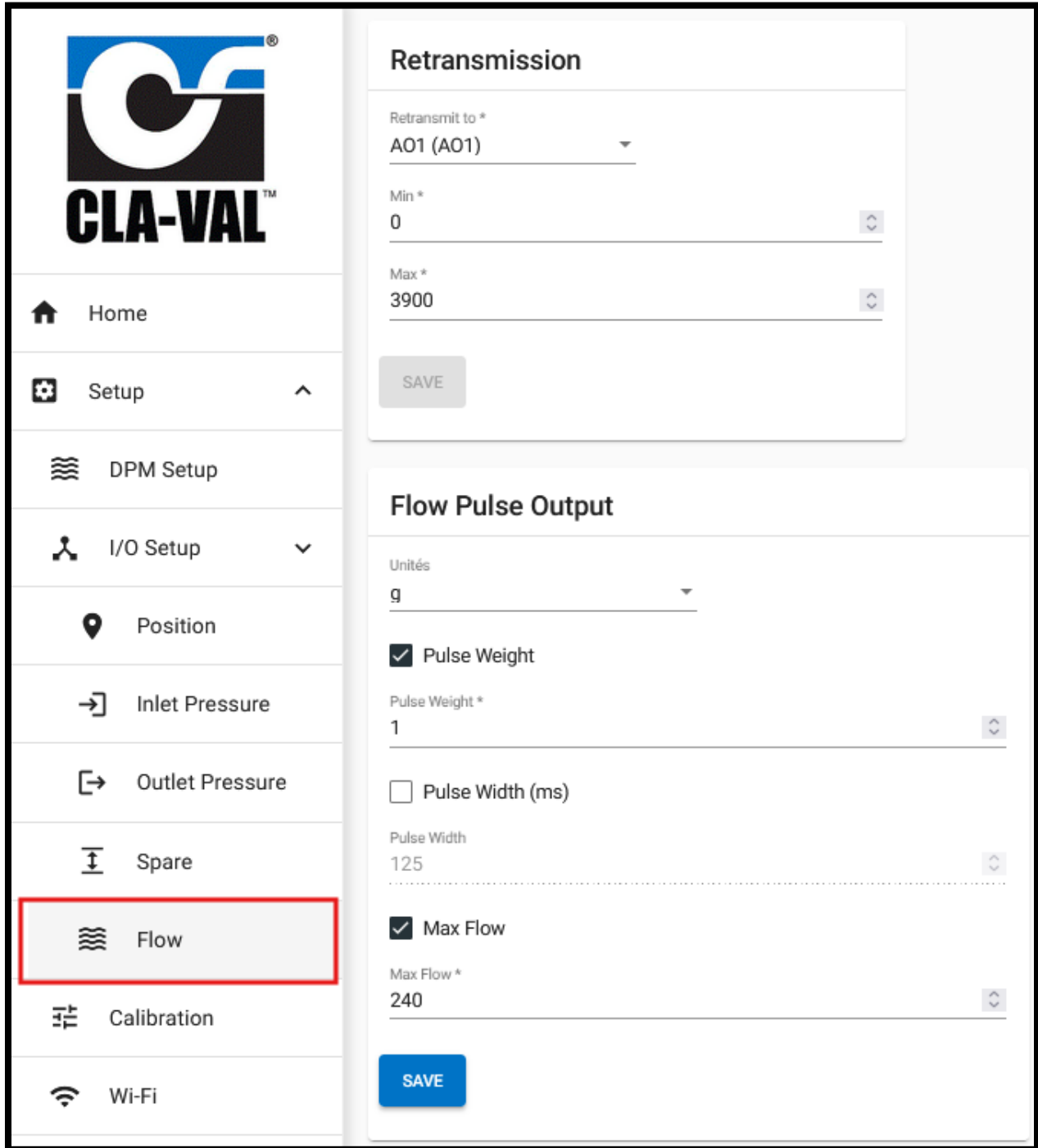

Figure 4.56

4.5.4.4.1 Flow Retransmission

Flow retransmission allows for the transmission of the calculated flow value from X35 module to any available output, the default of flow retransmission is AO1 and no scaling of the output as every valve size is different in scaling, setting up the scaling is essential for mA generation through analog output.

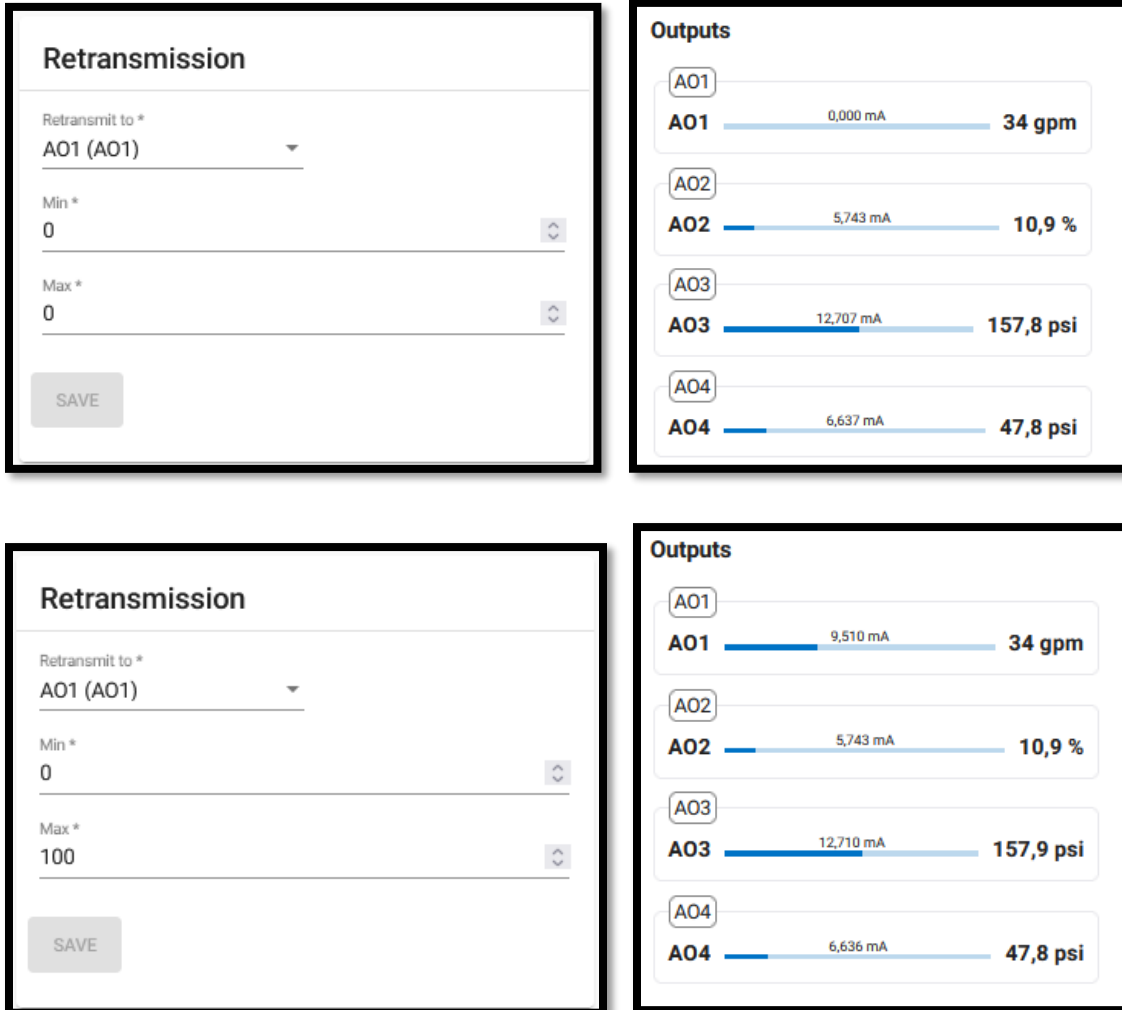
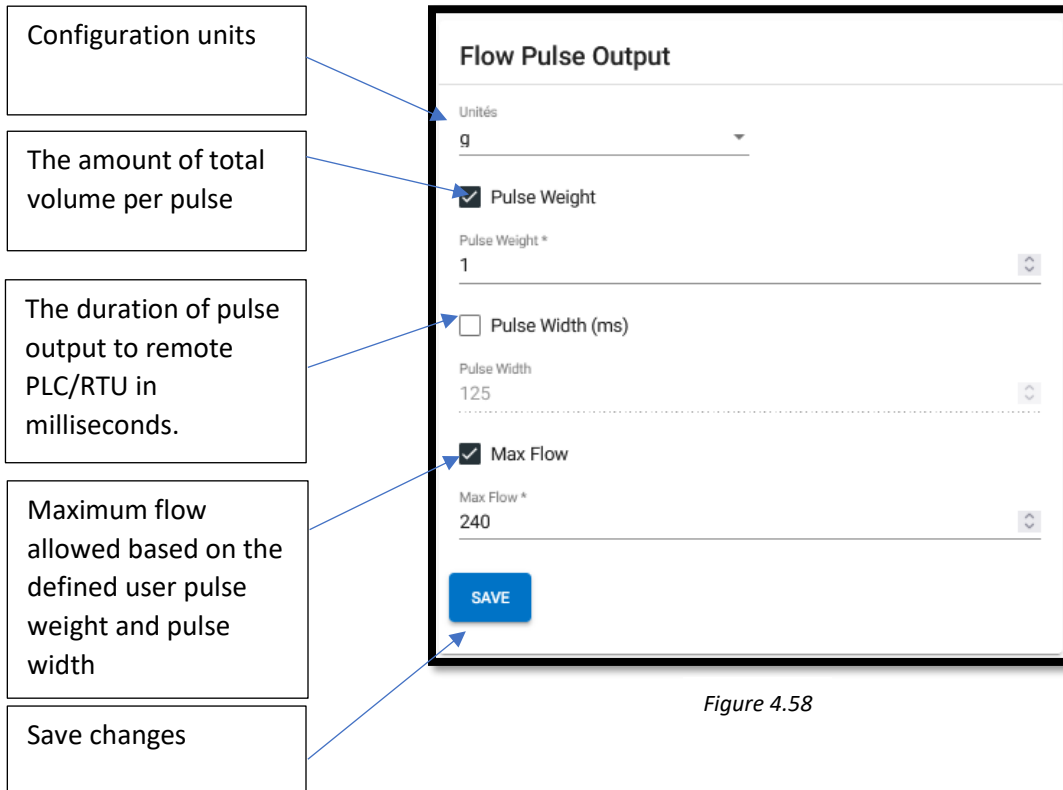

Figure 4.57

4.5.4.4.2 Flow Pulse Output

The totalizer digital output allows the configuration of parameters which are generated as pulses sent to an input card of a PLC, RTU, etc.



The screenshot shows a configuration window titled "Flow Pulse Output". On the left, five callout boxes with arrows point to specific elements in the interface:

- Configuration units:** Points to the "Unités" dropdown menu, which is currently set to "g".
- The amount of total volume per pulse:** Points to the "Pulse Weight" checkbox, which is checked. Below it, the "Pulse Weight\*" field is set to "1".
- The duration of pulse output to remote PLC/RTU in milliseconds:** Points to the "Pulse Width (ms)" checkbox, which is unchecked. Below it, the "Pulse Width" field is set to "125".
- Maximum flow allowed based on the defined user pulse weight and pulse width:** Points to the "Max Flow" checkbox, which is checked. Below it, the "Max Flow\*" field is set to "240".
- Save changes:** Points to the blue "SAVE" button at the bottom of the configuration panel.

Figure 4.58

4.5.5 Calibration

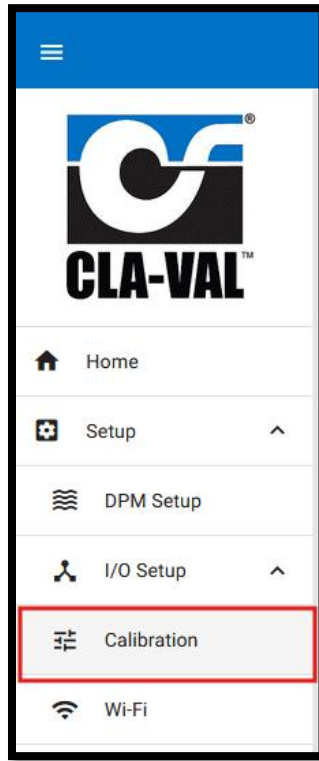

Figure 4.59

4.5.5.1 Input Calibration

**Description:** Used when the milliamps/volts m Figure5.18 an input channel on the X35 differ from the value measured on a multimeter or PLC/SCADA system. Allows the discrepancy to be eliminated.

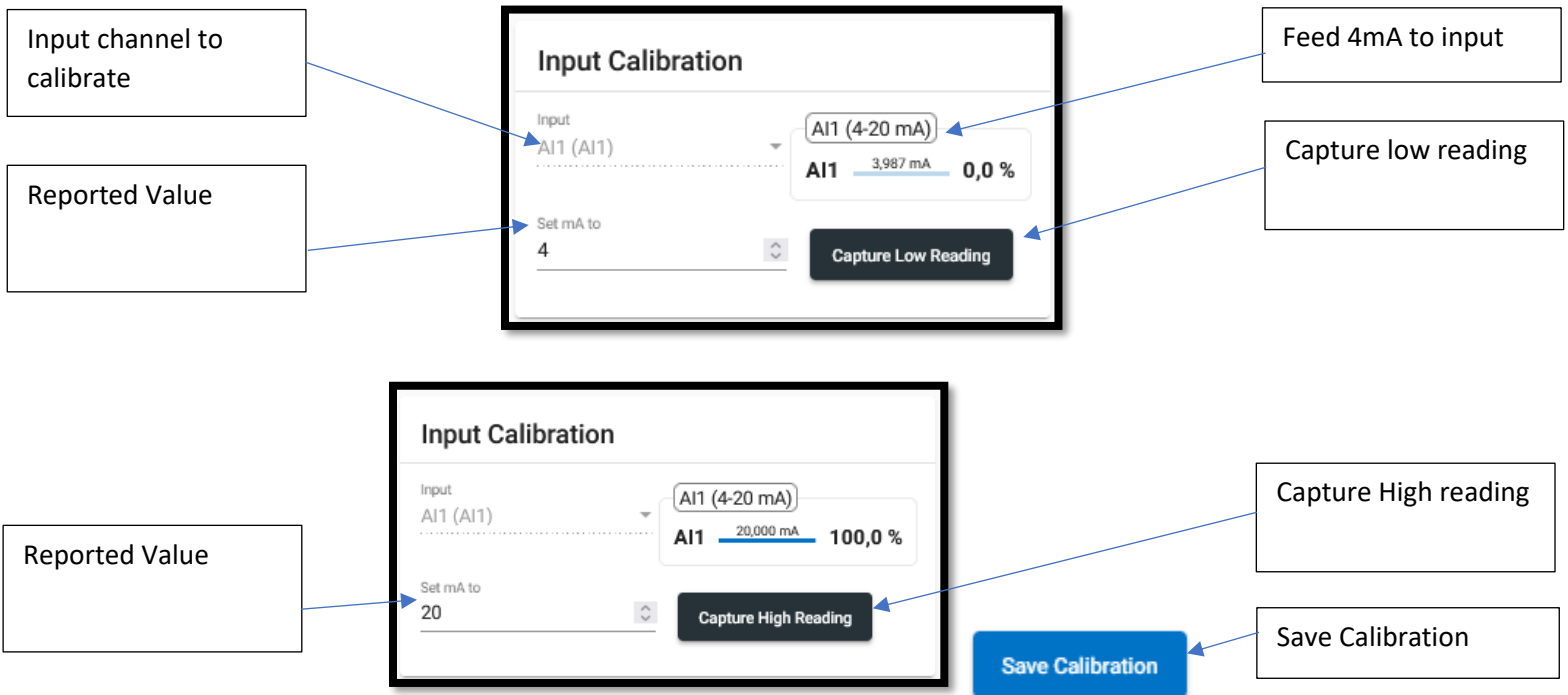

Figure 4.60

4.5.5.2 Output Calibration

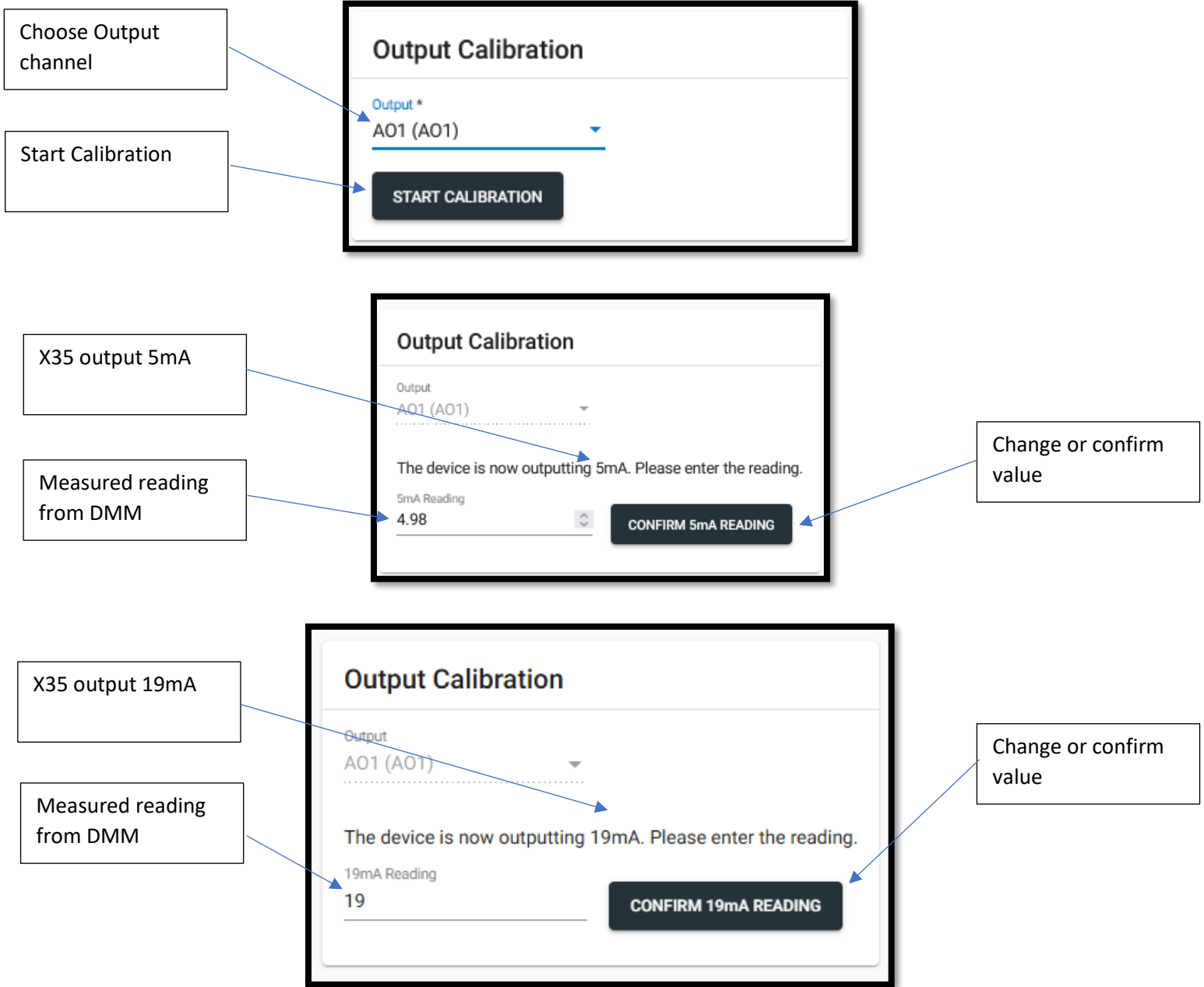

Figure 5.20

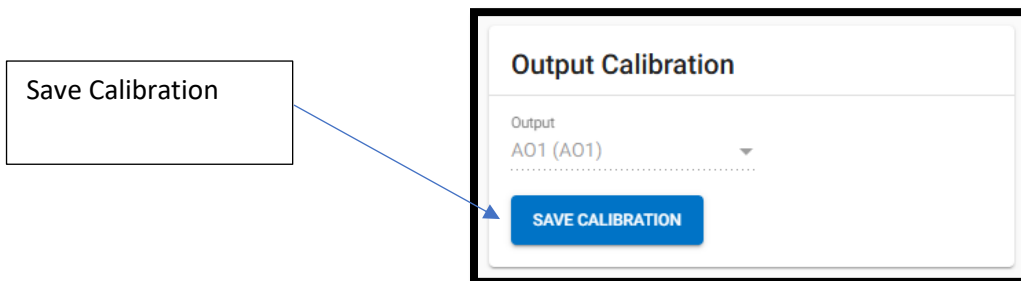

Figure 4.61

4.5.6 WI-FI settings

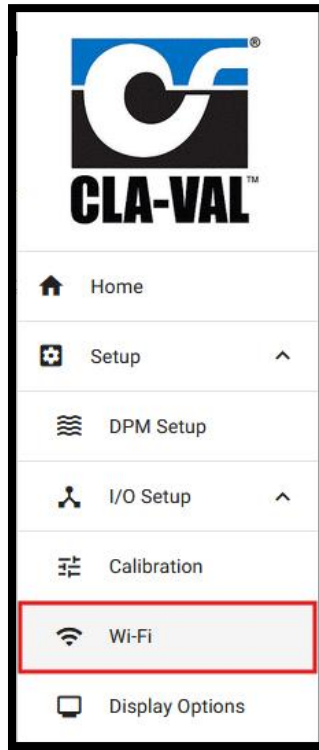
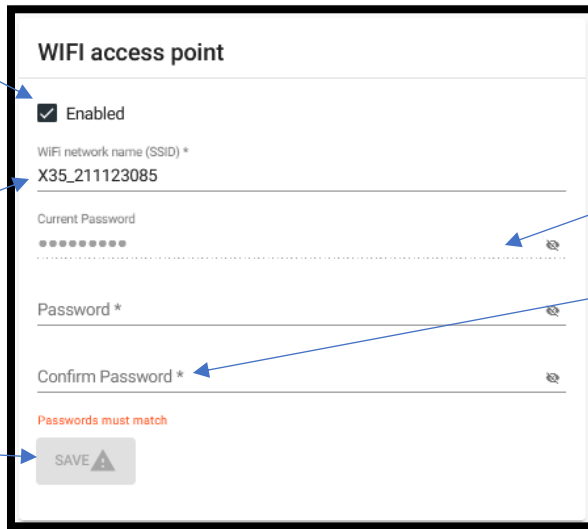

Figure 4.62

Disable WI-FI, enabling WI-FI through X35 module if disabled through WI-FI Configuration

WI-FI network default name with the ability to modify name

Save changes



Show current/default password

Change password

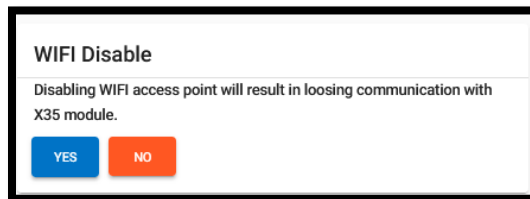

Figure 4.63

4.5.7 Display Options

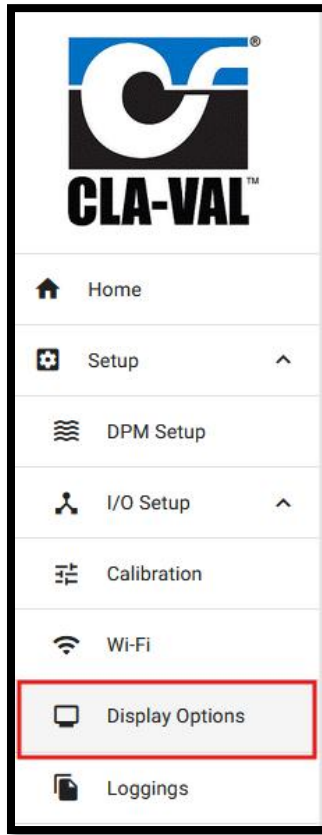

Figure 4.64

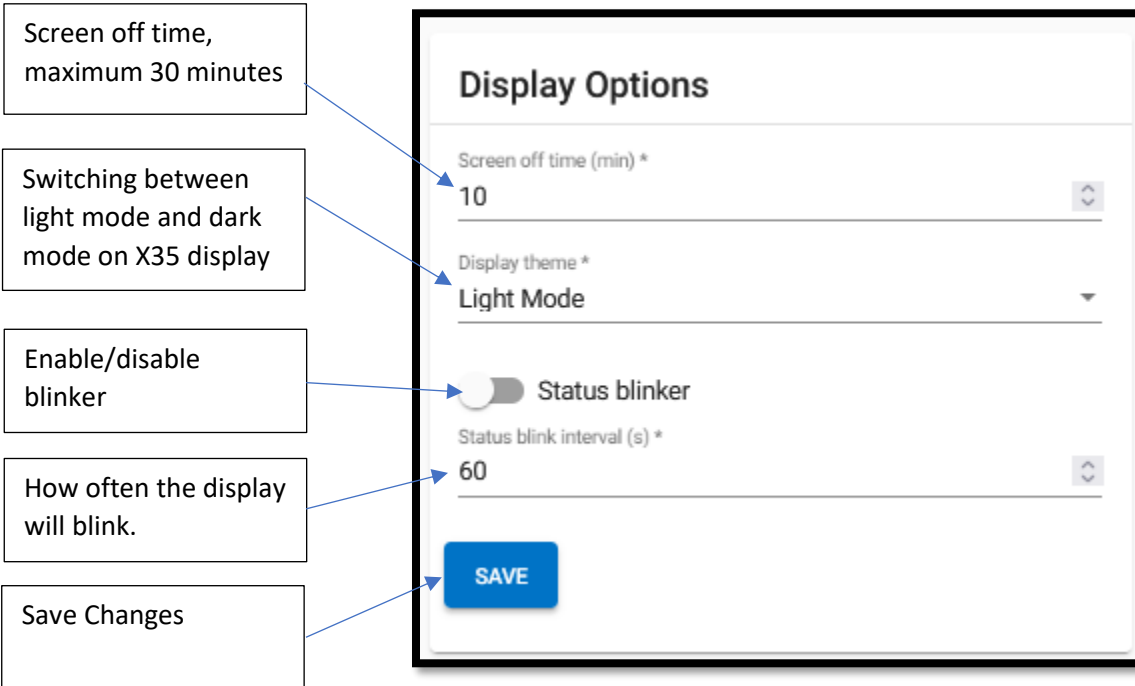

Figure 4.65

4.5.8 Loggings

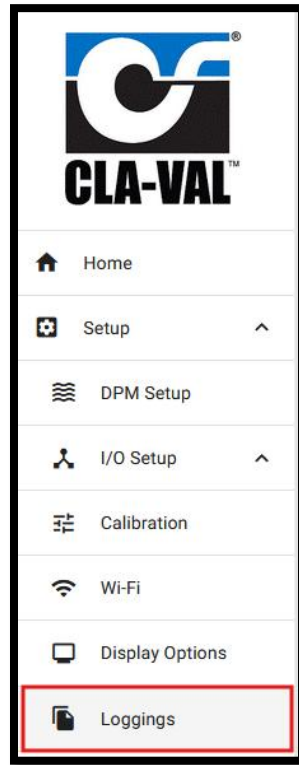

Figure 4.66

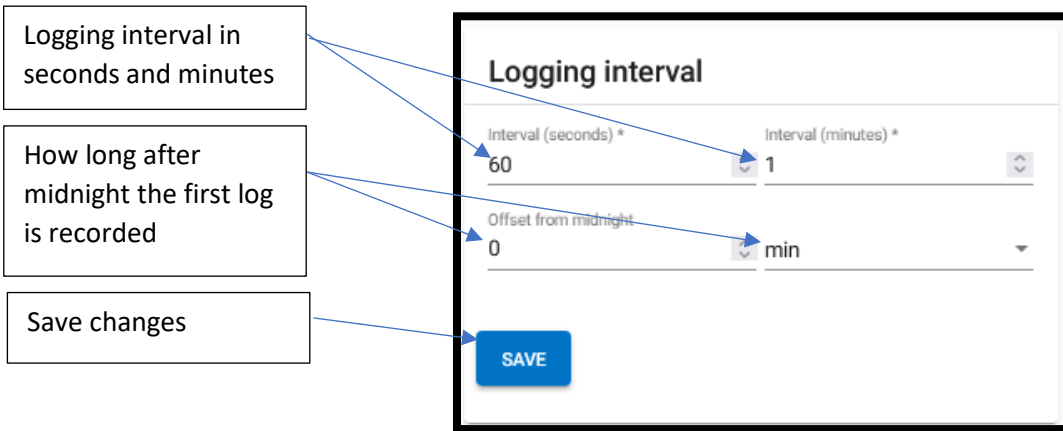

Figure 4.67

4.5.9 Date/Time

**Description:** Used to set current date and time. Date and time formats can also be changed.

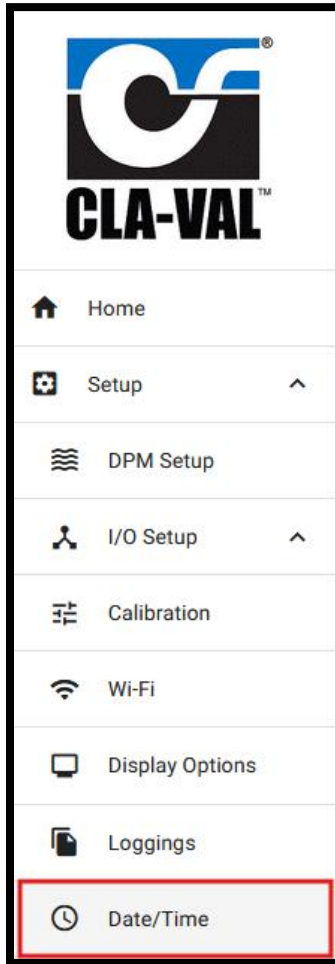

Figure 4.68

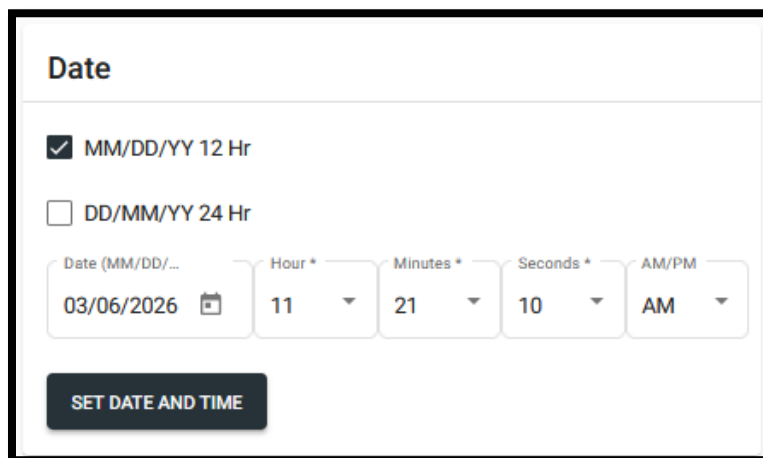

Figure 4.69

4.5.10 Language

**Description:** Used to change the language on X35 display to one of the supported languages by the module.

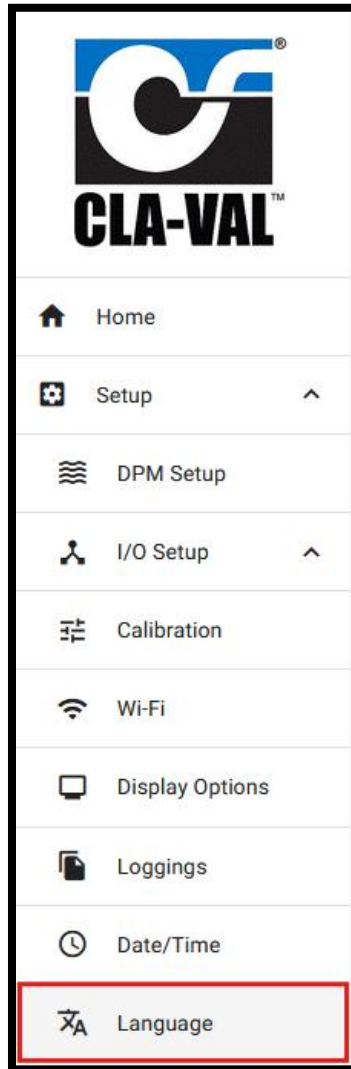

Figure 4.70

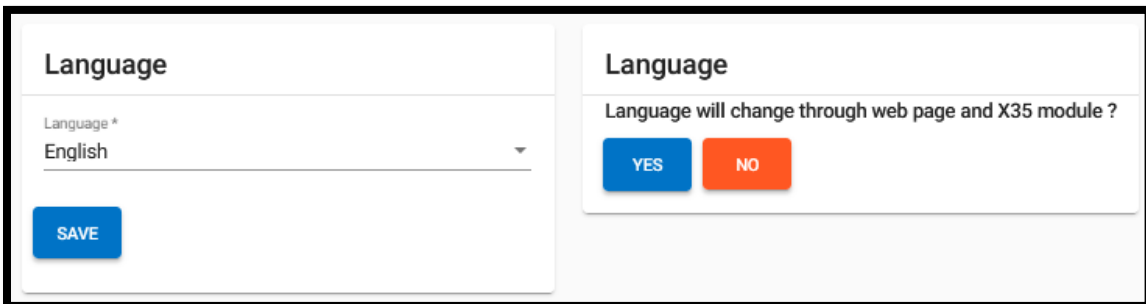

Figure 4.71

#### 4.5.11 Factory Reset

**Description:** used to reset all settings back to factory defaults, this includes the SSID WI-FI network and password.

**\*\*Note:** refer to section 4.4.7 for default WIFI SSID and password in the case of a factory reset.

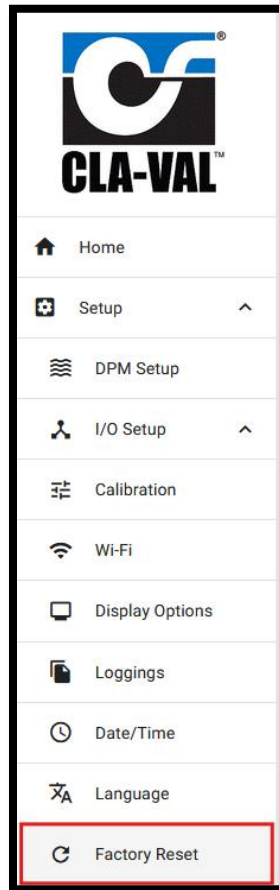

Figure 4.72

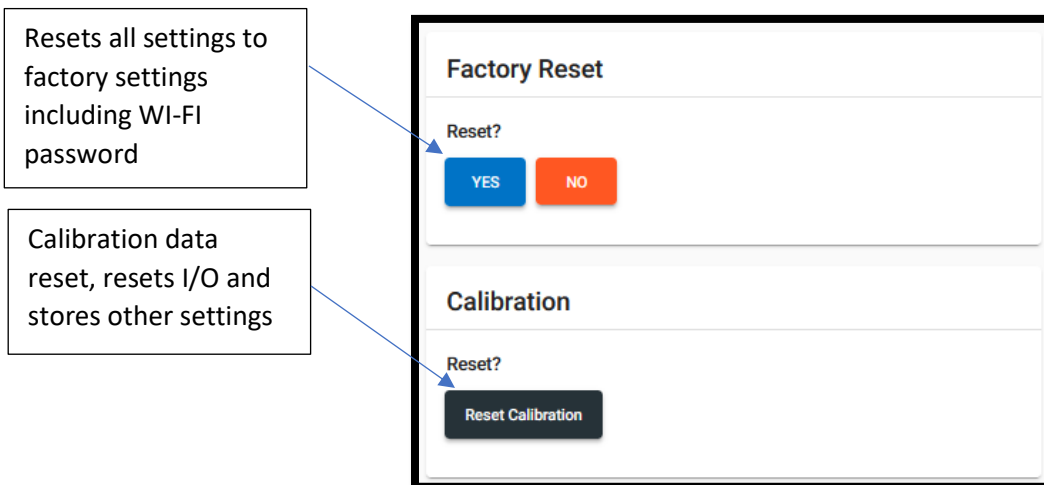

Figure 4.73

4.5.12 Security

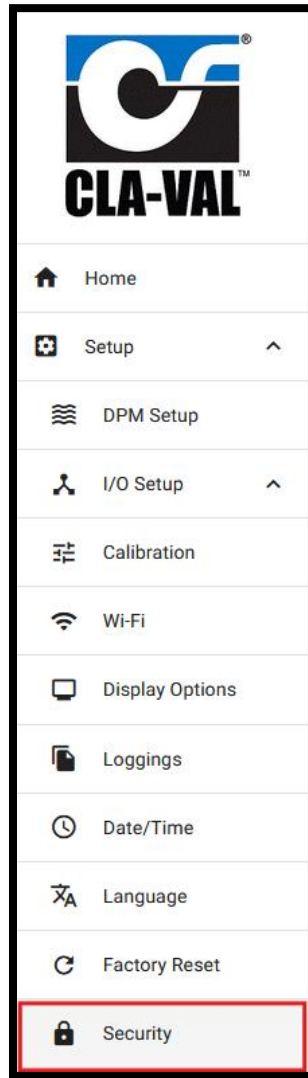

Figure 4.74

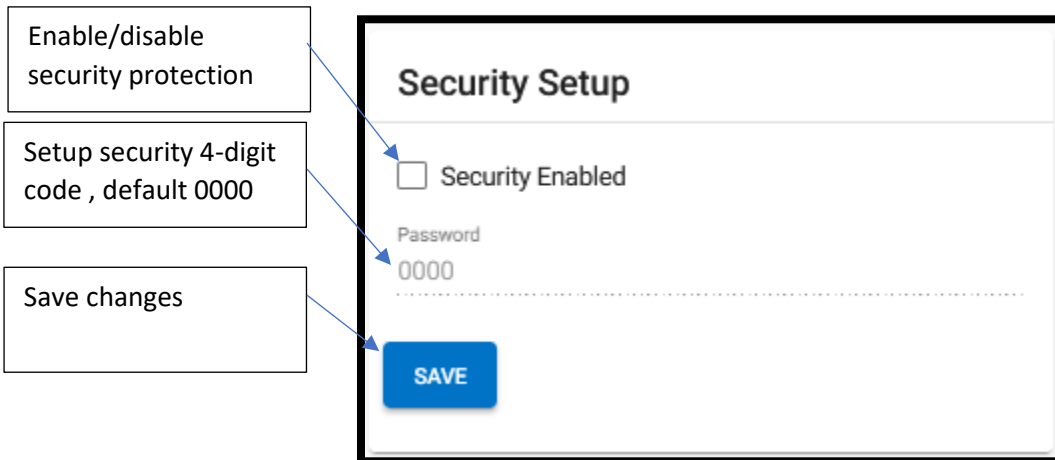

Figure 4.75

## 4.6 SD Card Features

### 4.6.1 SD Card Removal

**Note: Make sure to remove power from the X35 before removing the internal SD card or you may corrupt the data!**

Once power has been disconnected, follow the steps below to remove the SD card:

1. Push the SD card in and release to eject.

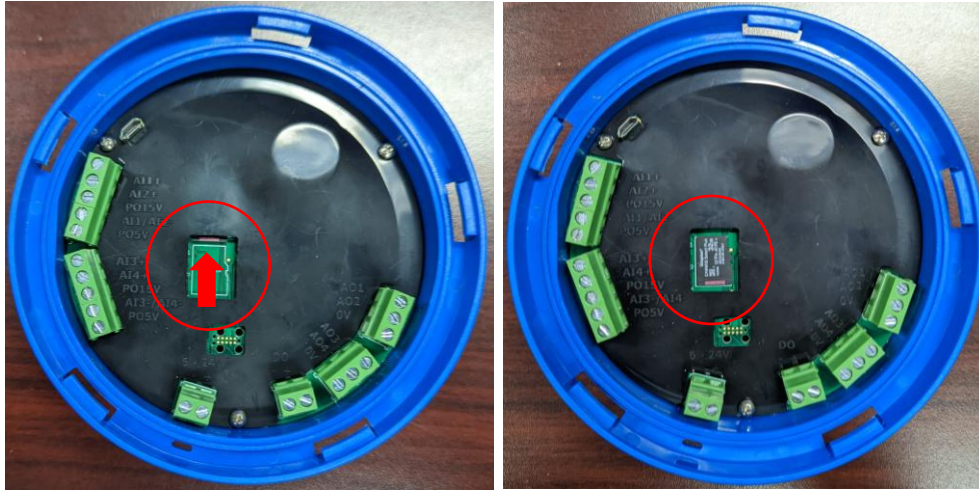

Figure 4.76

2. Use your finger to slide the SD card into the middle of the opening, as shown above, before trying to remove.
3. Either *carefully* pick up the SD card, ensuring it does not fall under the black plastic cover, **OR** **more easily**, hold the SD card against the board with your finger and then flip the module over and remove your finger. SD card should be on top of finger.



Figure 4.77

4.6.2 Access Logged Data

To access exported X35 logs, you will need access to a MicroSD card reader.

1. Insert the SD card into your PC and locate the Root directory shown in **Figure 4.40**.
2. Any exported Logs will be shown here as .zip folders.
3. Copy any needed log files to your PC then safely remove the SD card.

**WARNING – DO NOT Modify or delete any other files/folders!**

4. The copied zip files should be extracted to access the .csv log file.
5. After log files have been copied, insert the SD card back into X35 and connect power.

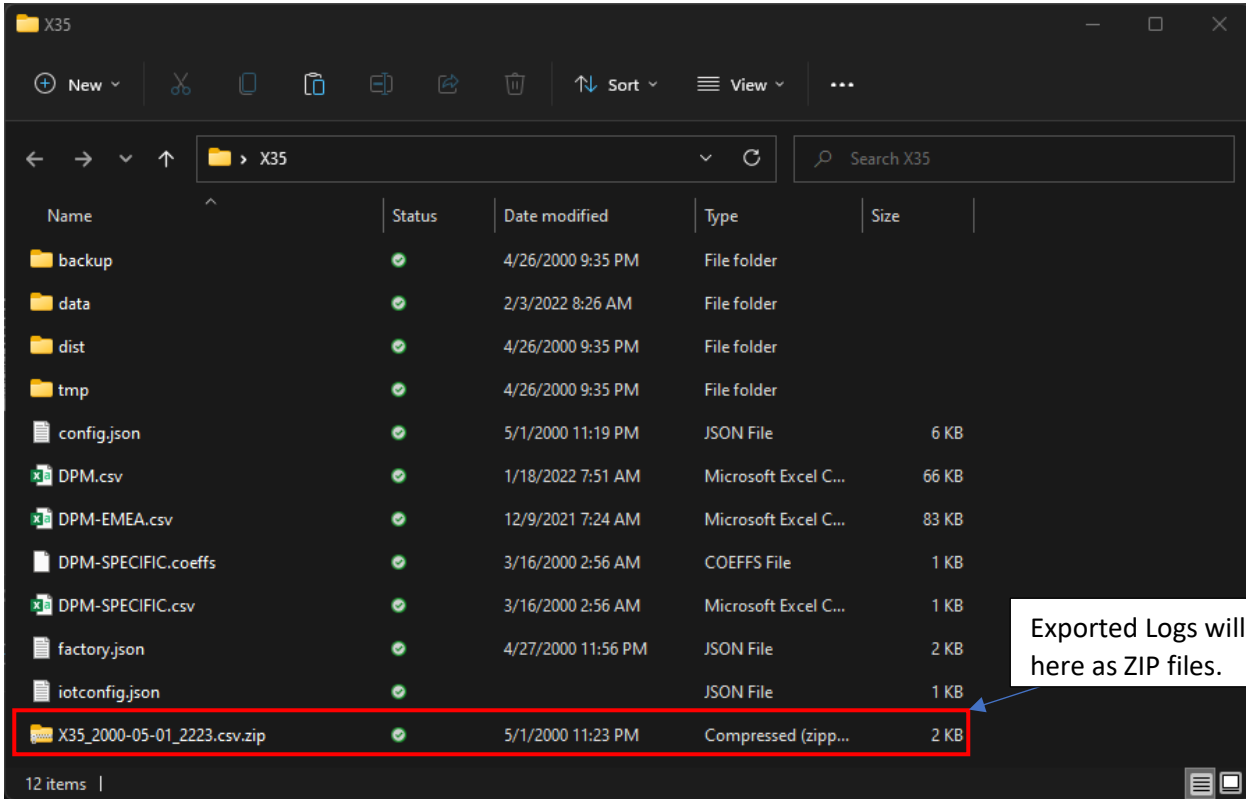

Figure 4.78

4.7 Firmware Update

4.7.1 Firmware Version

**\*\*Note: If updating to v2.0.0, following sections 1 and 2 are required.**

To update the X35 firmware, you will need to check which firmware is currently installed to X35 and if an update is necessary, to access the current firmware version on X35 navigate via: **Setup > Factory Reset >** bottom of the page will show the current firmware that’s installed on X35, as shown in figure 4.37.

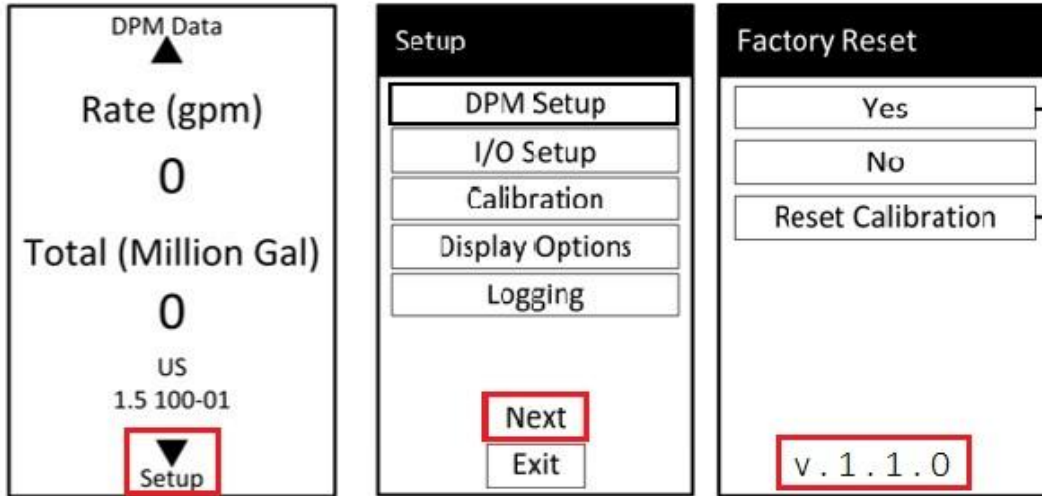

Figure 4.79

4.7.2 Firmware Download

To be able to download the latest firmware for X35, visit [www.cla-val.com](http://www.cla-val.com), clicking on resources and accessing software and driver library as shown in figure 4.38.

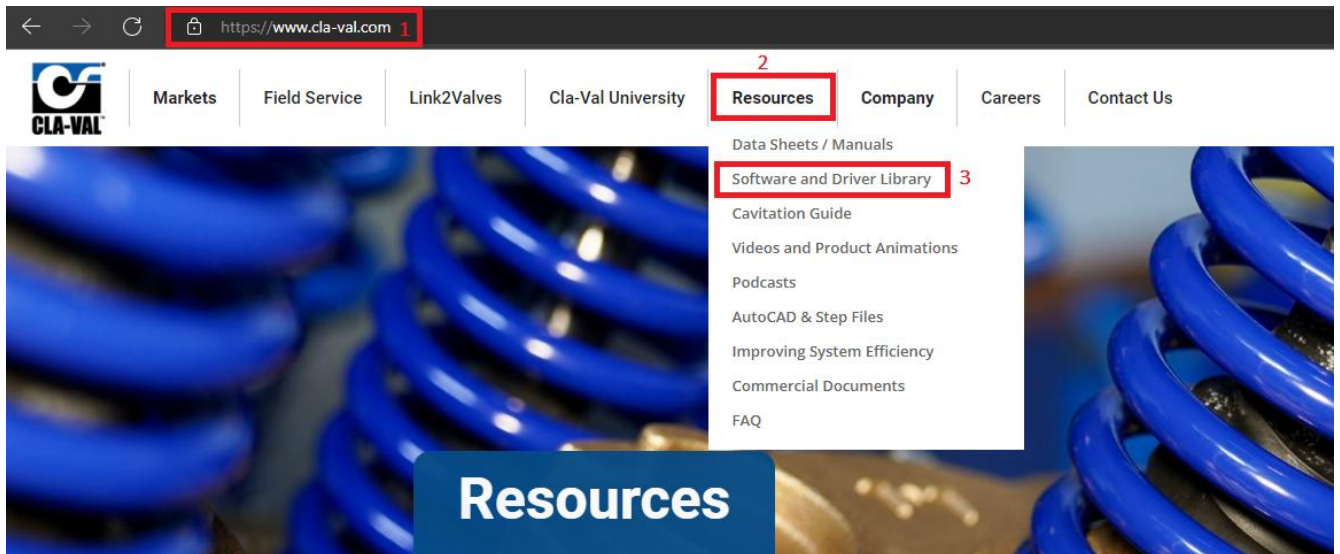

Figure 4.80

After accessing the software and driver library, choose X35 firmware and download file by clicking on the desired firmware, one click should automatically download file into Computer, as shown in figure below:

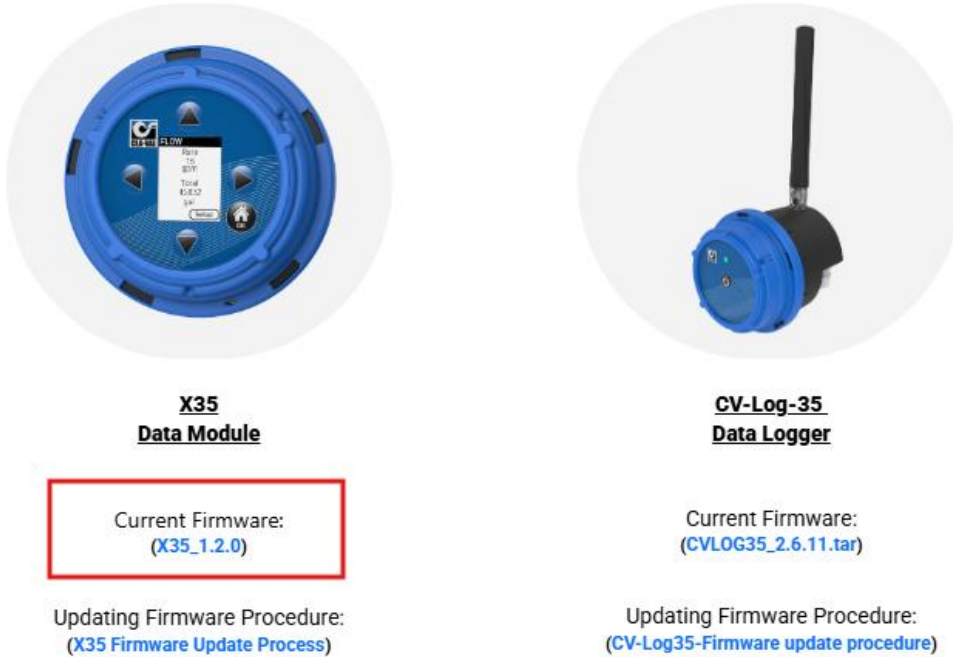

Figure 4.81

#### 4.7.3 SD Card Removal

**Note: Power must be disconnected prior to removing SD card from X35, and power must be off when inserting SD card to X35.**

Once power has been disconnected, follow the steps below to remove the SD card:

4. Push the SD card in and release to eject.

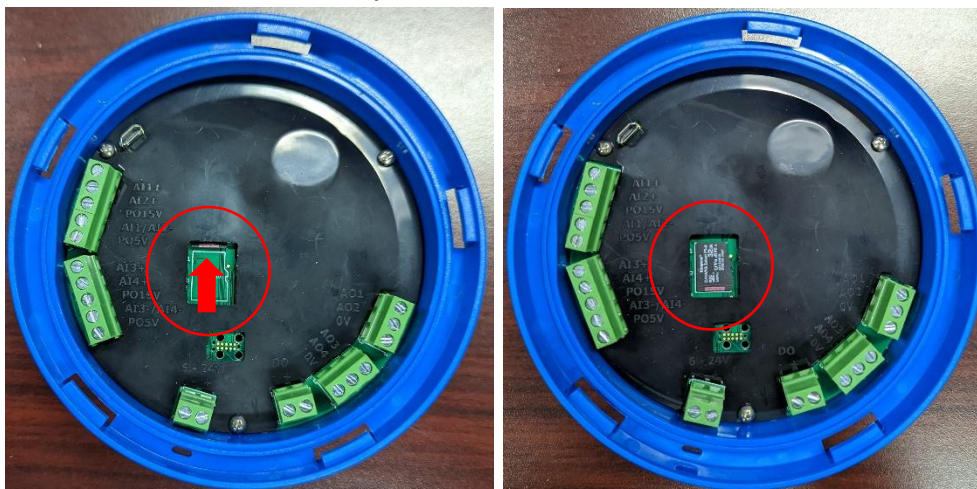

Figure 4.82

5. Use your finger to slide the SD card into the middle of the opening, as shown above, before trying to remove.
6. Either *carefully* pick up the SD card, ensuring it does not fall under the black plastic cover, **OR** **more easily**, hold the SD card against the board with your finger and then flip the module over and remove your finger. SD card should be on top of finger.



Figure 4.83

#### 4.7.4 Firmware Update

To update the X35 firmware, you will need access to a MicroSD card inserted in the back of the X35.

1. Insert the SD card into your PC and locate the Root directory shown in **figure 4.42**.
2. Move the file that you received or downloaded which is in a ".zip Format" into the "dist" folder.  
**WARNING – DO NOT Modify or delete any other files/folders!**
3. After the ".zip file" move is complete, safely remove the SD card from PC and insert back into the X35. When you connect power back to the module, the firmware update will begin on startup as shown in figure 4.43.

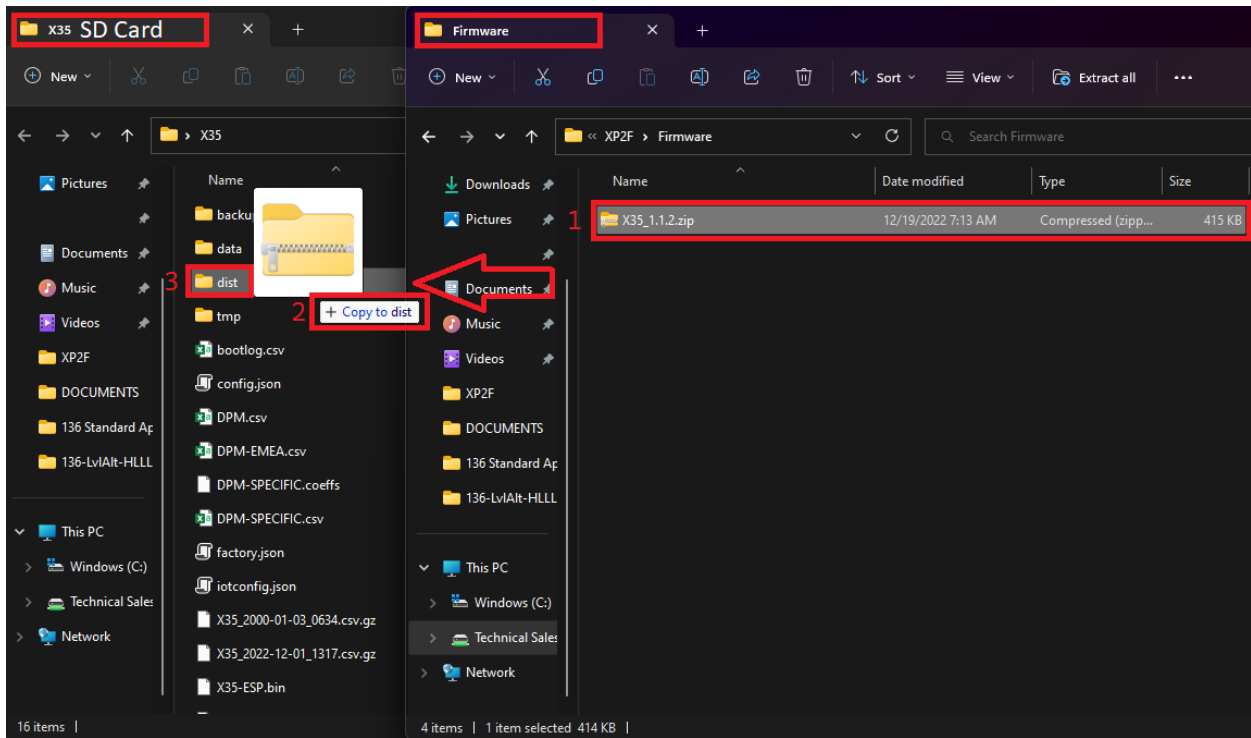

Figure 4.84

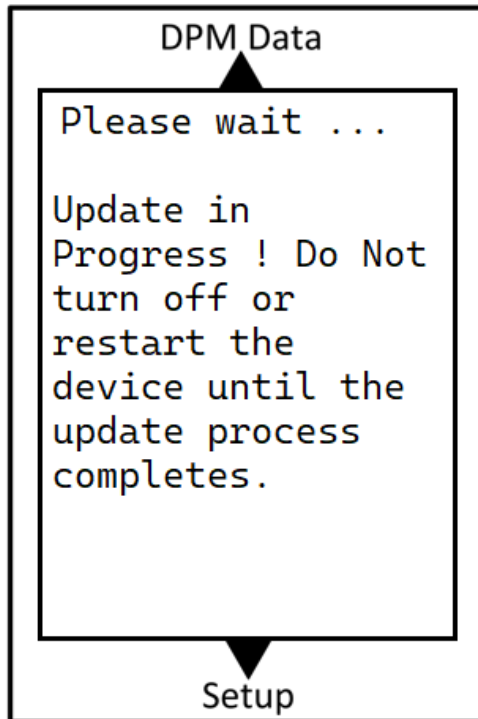

Figure 4.85

4.7.5 V2.0.0 Firmware update

If the version updated in section 1 of this document is v2.0.0 and after a successful update procedure of the X35 to V2.0.0 as shown in Figure 4.44, the repeat of the update procedure/steps 1.1.3 – 1.1.4 (second time firmware update), is required to fully update X35 to v2.0.0.

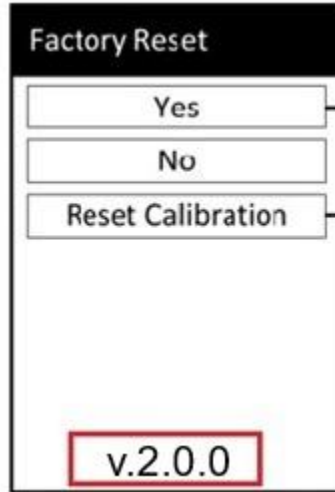

Figure 4.86

The first-time update enables the WI-FI mode in v2.0.0 , the second time update enables the access of the X35 IP address 192.168.4.1 through a browser in v2.0.0.

**Note: Power must be disconnected prior to removing SD card from X35, and power must be off when inserting SD card to X35.**



Figure 4.87

#### 4.7.6 Firmware Malfunction

Firmware Malfunctions can occur and its always something to be prepared for, such common causes of malfunction can happen because of SD card malfunction which can happen if SD Card is disconnected while X35 is still in power, corrupt SD Card, or even an uncomplete transfer of new Firmware to SD Card.

Identifying a Malfunction is the first step towards restoring a proper Firmware, a Firmware Malfunction could be a non-powering X35 after update is being installed, or incomplete process configuring the valve specifications and not loading the correct data for a specific valve.

If in any case a Malfunction occurs and X35 is not loading Correct data, incomplete bootup, steps below should solve this matter:

1. Disconnect SD card from X35 and insert into PC and start by having a complete format to SD card as shown in figure 4.44.

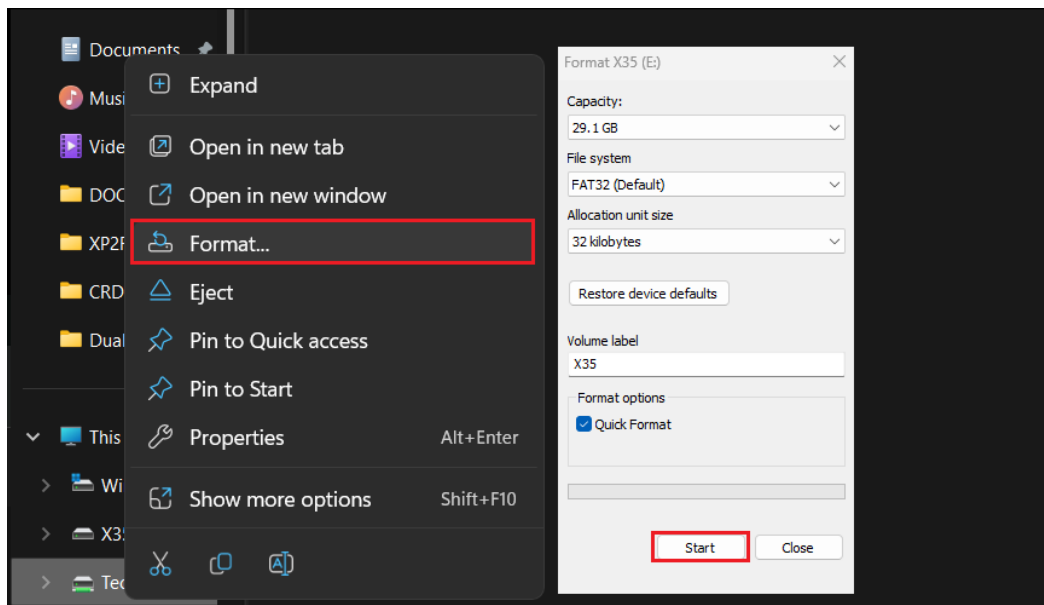

Figure 4.88

2. Copy the existing or new firmware internal files into SD card as shown in figure 4.45.

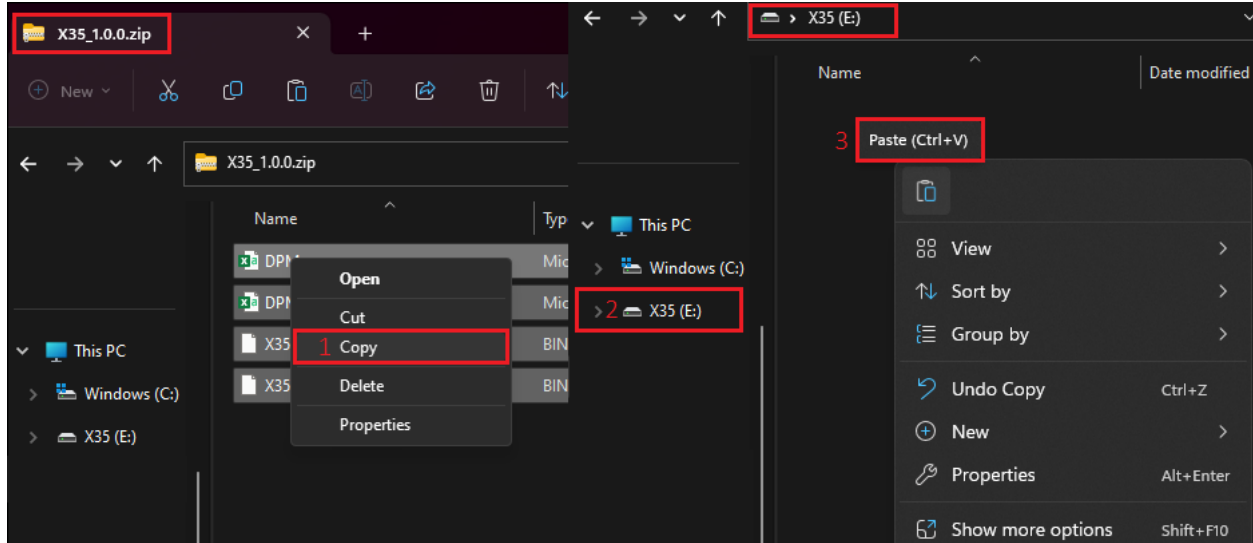

Figure 4.89

3. After the copy is complete, safely remove the SD card from PC and insert back into the X35. When you connect power back to the module, the firmware update will begin on startup.

**Note:** Do not power off or restart device during update process.

## 4.8 Digital Totalizer Output

### 4.8.1 Digital Totalizer Output Configuration

Some users want to totalize the flow using a pulsed output instead of a 4-20 output or in accordance with it. The pulses will be proportional to flowrate, for example, number of gpm per pulse. The output can be wired into a flow computer, PLC, or external counter.

The pulse flowmeter generates the digital pulses in form of 1 and 0 when measuring flow. The more the flow the faster would be the pulses generated. The X35 output pulses are generated to an input card of a PLC, RTU, etc.

The following parameters are essential for the totalizer output setup:

1. Pulse Weight: The amount of total volume per pulse.
2. Pulse Width: The duration of the pulse output to the remote PLC/RTU in milliseconds.
3. Max Flow: the maximum flow allowed based on the defined user pulse weight and pulse width.

The relationship between the previous parameters is as follows:

**Maximum flow rate =  $[1 / (2 * \text{pulse width})] * \text{Pulse Weight}$ .**

user can determine two of the three values and the third will be determined by equation above. To access the X35 Totalizer output setup page Navigate via: Setup > I/O > Flow Pulse, **FIGURE 4.48**.

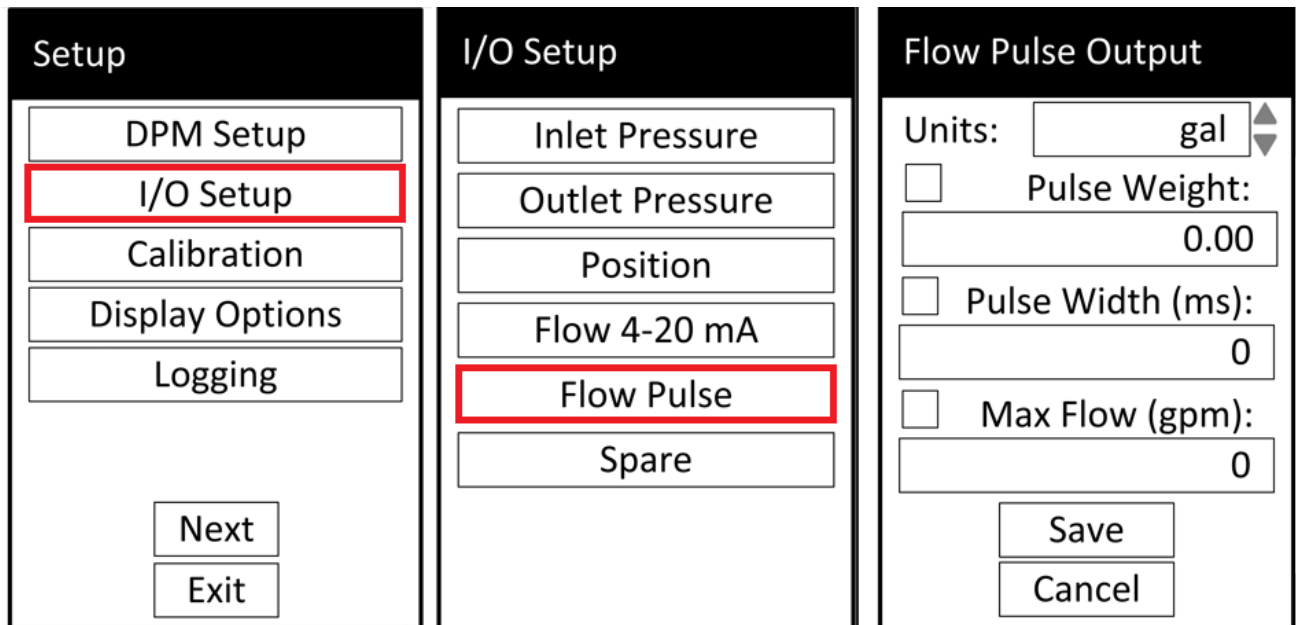

The figure shows three sequential menu screens for configuring the digital totalizer output. The first screen, 'Setup', has 'I/O Setup' highlighted with a red box. The second screen, 'I/O Setup', has 'Flow Pulse' highlighted with a red box. The third screen, 'Flow Pulse Output', contains the following settings:

- Units: gal
- Pulse Weight: 0.00
- Pulse Width (ms): 0
- Max Flow (gpm): 0

Buttons for 'Save' and 'Cancel' are located at the bottom of the 'Flow Pulse Output' screen.

Figure 4.90

Flow Calculation can be determined in few different ways:

1. User's need to maximize resolution from pulse output:
  - a. User sets the minimum pulse width that can be detected by PLC, RTU, etc.
  - b. User sets the maximum flow rate of the valve "based on configured valve size".
  - c. X35 module calculates and displays resulting pulse weight which is used to calculate flow in total.
2. User's need to pick a convenient pulse weight and covers the entire flow range of the valve:
  - a. User sets the pulse weight.
  - b. User sets the maximum flow rate of the valve "based on configured valve size".
  - c. X35 module calculates and displays resulting pulse width which is used as an input to ensure its not exceeding PLC, RTU, etc Capabilities.
3. Users need to pick up a convenient pulse weight, and a concern about pulse width due to slower PLC, RTU, etc.
  - a. User sets pulse weight.
  - b. User sets minimum pulse width that can be detected.
  - c. X35 module calculates and displays the resulting maximum flow that can be transmitted.

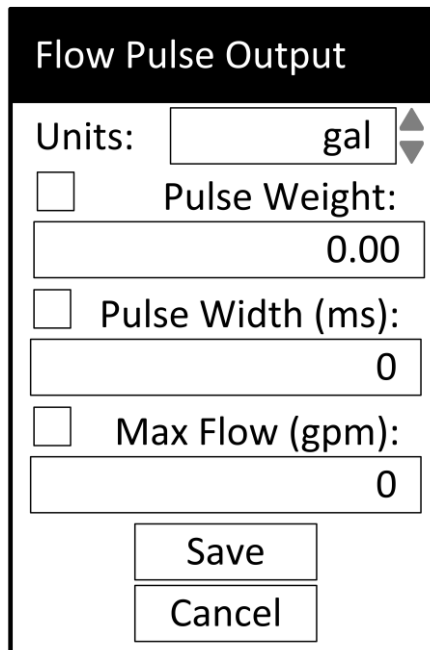
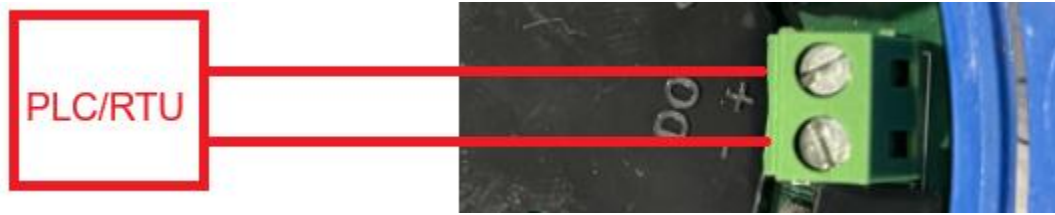

Figure 4.91

In order to successfully output pulses from X35 and make digital totalizer output possible, the Digital input of X35 had to change from a wet contact to a dry contact. This function was made possible by creating a Plug-in board that converts wet contact with voltage into a dry contact with a pulse output.

4.8.2 Digital Output

models of X35's include a Digital Output Totalizer that connects directly to PLC/RTU, refer to section 4.4.9.4 for a WI-FI configuration of flow pulse output.



4.8.3 Digital Totalizer Output Plug-In Board

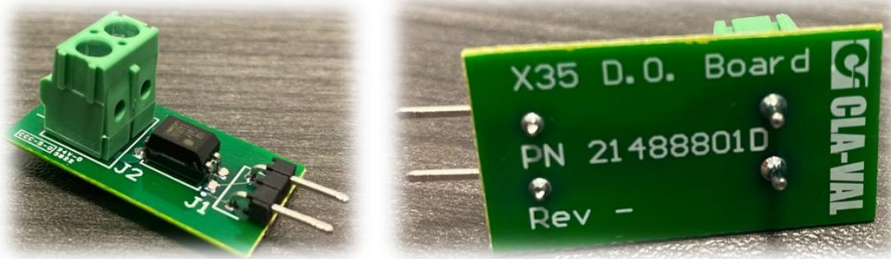

Figure 4.92

**\*\*Note: this section applies to units shipped before February 2026 as newer units include the output totalizer as a built-in feature.**

**\*\*Note: Power must be disconnected from X35 prior to installation for Digital Output Totalizer Plug-In Board.**

1. Locate Digital Output "DO +/-" Terminals on the X35.



Figure 4.93

2. Install Digital Output Totalizer Plug-In Board as per below.

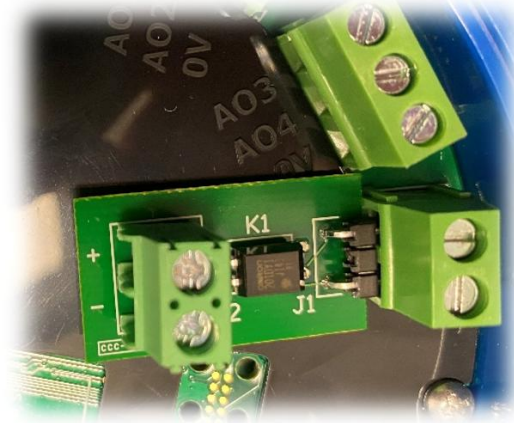
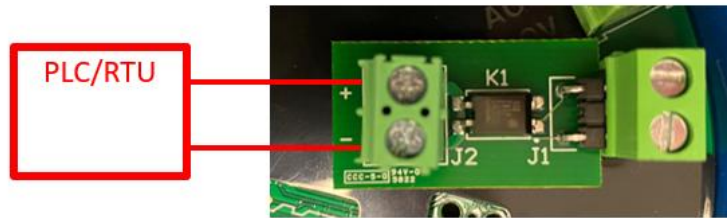

Figure 4.94

3. Wire as per below for totalizer output to PLC or RTU.



Dry Contact - 60VDC Rated

Figure 4.95

4. Setup X35 Totalizer output settings as mentioned prior in **section 4.8**.



## 5 XP2F-X35 START-UP CHECKLIST

### 5.1 Control Valve Setup

- Ensure control valve is installed in proper flow direction.
- If new control valve, ensure installed as per valve IOM. If existing valve, ensure valve has received recent service and is in good working condition.
- Ensure air is bled from main valve cover via bleed screw.
- Adjust any speed controls, restriction fittings exists based on site conditions.
- Ensure ability close valve to verify/setup Valve Position Sensor and open valve to flow water to verify/setup X35 and hydraulic pilots.

### 5.2 Component Configuration

- Ensure all XP2F components are available.  
\*\*Note: Standard XP2F configuration consists of 2x X141-PT and 1x X117H
- Ensure X117H Valve Position Sensor (or alternative position sensor) is installed as per IOM.
- Ensure X141-PT Pressure Sensors (or alternative pressure/DPT sensor(s)) is installed as per IOM.

### 5.3 X35 Wiring Configuration

- Ensure VDC Power is connected as per IOM.
- Ensure 4-20mA Analog Inputs is connected as per IOM.
  - Valve position
  - Upstream pressure, downstream pressure, or alternative differential pressure.
- Ensure 4-20mA Analog Outputs (if required) is connected as per IOM.
  - Instantaneous Valve Flow
  - Valve position
  - Upstream pressure, downstream pressure, or alternative differential pressure.
- Ensure Flow Totalizer output wiring (if required) is connected as per IOM.

### 5.4 X35 Power Activation

- Verify Incoming power.
  - Ensure incoming power is within 9-24VDC.
  - Ensure enough charging power to battery if using Cla-Val Power Generator or Alternative Solar Panel Installation.  
\*\*Note: If unsure please contact Cla-Val representative to provide you a full power draw calculation for your application.
- Turn Power on to the X35 and ensure X35 powers up with no errors or issues.

### 5.5 X35 DPM Setup

- Verify "Valve" setup configuration.
  - Navigate via Setup > DPM Setup > Valve.
    - Ensure "US" or "METRIC" selection of units.
    - Ensure selection of valve size
      - Refer to Cla-Val valve tag.
    - Ensure selection of valve body style,
      - Refer to Cla-Val valve tag.
    - Ensure selection of valve bodies seat

- Ensure selection of valve pressure transmitters installation position
  - \*\*Note: Boss-Boss = Pressure transmitters are connected to valve ports
  - \*\*Note: Pipe-Pipe = Pressure transmitters are connected to main pipe ports.
- Verify “Flow” setup configuration.
  - Navigate via setup > DPM Setup > Flow.
    - Ensure selection of display flow units and decimals.
    - Ensure selection of low flow cutoff.
- Verify “Total” setup configuration.
  - Navigate via setup > DPM Setup > Total.
    - Ensure selection of display totalizer units and decimals.
    - Reset totalizer (if required).
- Verify “DPM Inputs” setup configuration.
  - Navigate via setup > DPM Setup > DPM Inputs.
    - Ensure selection of pressure sensor input configuration.
      - \*\*Note: P1 + P2 = Upstream and downstream transmitters.
      - \*\*Note: Delta P = Differential pressure transmitter.

## 5.6 X35 I/O Setup

- Verify “Inlet Pressure” setup configuration.
  - Navigate Via: Setup > I/O Setup > Inlet Pressure
    - Ensure selection of “Input” = “AI2”
    - Ensure selection of “Type” = “4-20 mA”
    - Ensure selection of sensor units and decimals per manufacturer
      - \*\*Note: See Transmitter Table Below
  - Navigate Via: Setup > I/O Setup > Inlet Pressure > Next.
    - Ensure selection of manufacture sensor Min and Max Scale
      - \*\*Note: See Transmitter Table Below
    - Ensure selection of “Filter” = “70”
  - Navigate Via: Setup > I/O Setup > Inlet Pressure > Next > Retransmission.
    - Ensure selection of “Retransmit to” = “AO3”
    - Ensure selection of manufacture sensor receives Min and Max Scale
- Verify “Outlet Pressure” setup configuration.
  - Navigate Via: Setup > I/O Setup > Outlet Pressure
    - Ensure selection of “Input” = “AI3”
    - Ensure selection of “Type” = “4-20 mA”
    - Ensure selection of manufacture sensor Units and decimals.
      - \*\*Note: See Transmitter Table Below
  - Navigate Via: Setup > I/O Setup > Outlet Pressure > Next
    - Ensure selection of manufacture sensor Min and Max Scale
      - \*\*Note: See Transmitter Table Below
    - Ensure selection of “Filter” = “70”
  - Navigate Via: Setup > I/O Setup > Outlet Pressure > Next > Retransmission.
    - Ensure selection of “Retransmit to” = “AO4”
    - Ensure selection of manufacture sensor Min and Max Scale
- Verify “Position” setup configuration.
  - Navigate Via: Setup > I/O Setup > Position
    - Ensure selection of “Input” = “AI1”



- Ensure selection of “Type” = “4-20 mA”
- Ensure selection of manufacture sensor Units and decimals.  
\*\*Note: See Transmitter Table Below
- Navigate Via: Setup > I/O Setup > Position > Next.
  - Ensure selection of manufacture sensor Min and Max Scale  
\*\*Note: See Transmitter Table Below
  - Ensure selection of “Filter” = “70”
- Navigate Via: Setup > I/O Setup > Position > Next > Retransmission.
  - Ensure selection of “Retransmit to” = “AO2”
  - Ensure selection of manufacture sensor Min and Max Scale

**Transmitter Table Values:**

Type	Product	Units	Min	Max
Valve Position	Cla-Val X117H/X117D	%	0	100
	Alternative	N/A	N/A	N/A
Pressure	Cla-Val X141-PT	PSI	0	290
	Alternative	See Product Datasheet	See Product Datasheet	See Product Datasheet

- Verify “Flow 4-20 mA” setup configuration.
  - Navigate Via: Setup > I/O Setup > Flow 4-20 mA
    - Ensure selection of “Retransmit to” = “AO1”
    - Ensure selection of “Min” = “0”
    - Ensure selection of Max Scale based on user preference or based on Valve Flow Appendix below
- Verify “Flow Pulse” setup configuration (if required)
  - Navigate Via Setup > I/O setup > Flow Pulse.
    - Ensure selection of totalizer pulse units
    - Ensure selection of the correct 2x of 3x options are highlighted for the application.
    - Ensure selection of pulse weight value (if required)
    - Ensure selection of pulse width (if required)
    - Ensure selection of max flow value (if required)

5.7 X35 Display Options Setup

- Verify “Display Options” setup configuration.
  - Navigate Via Setup > Display Options
    - Ensure selection of screen timeout time.
    - Ensure selection of preferred screen display mode.

5.8 X35 Configuration Logging Setup

- Verify “Configuration Logging” setup configuration.
  - Navigate Via Setup > Logging > Configure Logging
    - Ensure selection of preference for log entry interval
    - Ensure selection of offset log from midnight

5.9 X35 Date/Time Setup

- Verify “Date/Time” setup configuration.



- Navigate Via Setup > Next > Date/Time
  - Ensure selection of preference for 12hr or 24hr
  - Ensure selection of date
  - Ensure selection of time

**Valve Flow Appendix:**

Port Style	Line Size inches (mm)	2 (50)	2.5 (65)	3 (80)	4 (100)	6 (150)	8 (200)	10 (250)	12 (300)	14 (350)
<b>100-01</b>	Max Flow	210	300	460	800	1800	3100	4900	7000	8400
<b>Full Port</b>	GPM (l/s)	(13)	(19)	(29)	(50)	(113)	(195)	(309)	(442)	(530)
<b>100-01KO</b>	Max Flow	190	270	410	710	1620	2810	4420	6280	7590
<b>Full Port</b>	GPM (l/s)	(12)	(17)	(26)	(45)	(102)	(177)	(279)	(397)	(479)
<b>100-20</b>	Max Flow	Not Available		260	580	1025	2300	4100	6400	9230
<b>Full Port</b>	[GPM (l/s)			(16)	(37)	(65)	(145)	(258)	(403)	(581)
<b>100-20KO</b>	Max Flow	Not available		190	410	710	1620	2810	4420	6280
<b>Full Port</b>	GPM (l/s)			(12)	(26)	(45)	(102)	(177)	(279)	(396)

Port Style	Line Size inches (mm)	16 (400)	18 (450)	20 (500)	24 (600)	30 (750)	36 (900)	42 (1000)	48 (1200)
<b>100-01</b>	Max Flow	11000	14000	17000	25000	42000	50000	Consult Factory	
<b>Full Port</b>	GPM (l/s)	(694)	(883)	(1073)	(1577)	(2650)	(3150)		
<b>100-01KO</b>	Max Flow	9920	12550	14900	22600	37700	52450	Consult Factory	
<b>Full Port</b>	GPM (l/s)	(694)	(792)	(940)	(1427)	(2379)	(3309)		
<b>100-20</b>	Max Flow	9230	16500	16500	16500	28000	42000	57000	57000
<b>Full Port</b>	GPM (l/s)	(581)	(1040)	(1040)	(1040)	(1764)	(2650)	(3596)	(3596)
<b>100-20KO</b>	Max Flow	7590	9920	12550	14900	22600	38000	Consult Factory	
<b>Reduced Port</b>	GPM (l/s)	(479)	(626)	(792)	(940)	(1426)	(2098)		

5.10 X35 Analog Input Mapping and Signal

- Verify Analog Input Mapping
  - Navigate Left Arrow to “Inputs” Page
    - Ensure “AI1” = “XX%” Value representing Valve Position  
\*\*NOTE: mA value may not be present currently
    - Ensure “AI2” = “XX psi” Value representing Upstream Pressure
    - Ensure “AI2” = at least 3.5mA Value  
\*\*NOTE: If mA < 3.5mA verify Sensor and Sensor Wiring
    - Ensure “AI3” = “XX psi” Value
    - Ensure “AI3” = at least 3.5mA Value representing Downstream Pressure  
\*\*NOTE: If mA < 3.5mA verify Sensor and Sensor Wiring

5.11 Valve Position Setup and Zero Calibration

- Close Main Valve using isolation Ball Valves
- Calibrate approx. 4mA Signal from Valve Position Sensor
  - Navigate Left Arrow to “Inputs” Page
    - Adjust X117H or X117D signal as per IOM and verifying signal input on X35.



- Ensure "AI1" = Approximately between 4.0mA – 4.2mA Value
- Apply Channel Offset for Valve Position Sensor
  - Navigate Via: Setup > I/O Setup > Position > Next > Channel Offset
    - Ensure to Enable Channel Offset
    - Ensure "Target New Value" = "0.0"
    - Ensure to "Save"
- Verify Channel Offset for Valve Position Sensor
  - Navigate Left Arrow to "Inputs" Page
    - Ensure "AI1" = "0.0%" regardless of mA reading
- If using X117D (not required for X117H) calibrate approx. 20mA Signal from Valve Position Sensor
  - Open Main Valve using isolation Ball Valves
  - Navigate Left Arrow to "Inputs" Page
    - Adjust X117D signal as per IOM and verifying signal input on X35.
    - Ensure "AI1" = Approximately 20mA Value

### 5.12 Flow Testing and Verification

- Ensure Main Valve is open and Flowing Water
- Verify DPM Sensor Signal
  - Navigate "DPM Data"
- Verify flow Rate on main page.

### 5.13 X35 Analog Output Mapping and Signal

- Verify Analog Output Mapping
  - Navigate Right Arrow to "Outputs" Page
    - Ensure "AO1" = Flow Rate
    - Ensure "AO1" = mA representative of Flow Rate
    - Ensure "AO2" = Valve Position
    - Ensure "AO2" = mA representative of Valve Position
    - Ensure "AO3" = Inlet Pressure
    - Ensure "AO3" = mA representative of Inlet Pressure
    - Ensure "AO4" = Outlet Pressure
    - Ensure "AO4" = mA representative of Outlet Pressure

## 6 XP2F-X35 TROUBLESHOOTING GUIDE

### 6.1 Hardware Troubleshooting

- Verify if X-35 Module is Functioning and screen is ON.
  - If Module is successfully working move to next step.
  - If X-35 power up was not successful, check for incoming power, 9-32VDC.
  - Move to next step if not successful.
  
- Perform a Power Cycle to X-35 Module.
  - Check if issue has been resolved, if not move to next step.
  
- Format SD-Card and install latest Firmware.
  - Ensure to Format SD-Card and install latest Firmware by referring to Cla-Val website and following X35 Firmware update process Sheet.
  
- Perform a Factory Reset for X35 Module.
  - A Factory Reset to X35 Module may fixes any Hardware/software glitches.
  - Move to next step.
  
- Verify X35 is running the latest version.
  - Ensure X-35 is updated to latest version, referring to Cla-Val website and following X35 Firmware update process Sheet.
  
- In the case of power up and X-35 does not work check for:
  - Any Visible burning marks on the PCB Board.
  - Perform a continuity test on the overvoltage diode of the PCB Board.
  - If No Continuity, X-35 should be replaced.
  
- Ensure wiring is connected properly to X-35 Module.
  - Refer to XP2F IOM for Wiring diagrams.
  - If Faulty wiring, swap wiring and check functionality of X35.
  - Check If XP2F position transmitter is an X117H or X117D.
  - Check if an Inlet/Outlet pressure transmitter are used or a DP Transmitter.
  
- Verify if a custom curve or gain is required for specific application.
  - Navigate Via Setup > DPM Curve Adjust > Constant Gain/Custom Table.
  - Adjust Constant Gain as needed.
  - Create a Custom DPM Table as needed.



## 6.2 Software Troubleshooting

- Perform a Power Cycle to X-35 Module.
  
- Perform a Factory Reset
  - If any incorrect readings or Software glitches occur, perform a Factory Reset to X35 Module.
- Verify analog input reading of AI1 = Position Transmitter.
  - Verify Correct Reading and setting of X117H/x117D by Closing Valve and verify a 4mA Reading, if not Move to Next step.
  - If Valve is Fully Closed and AI1 reading is not 4mA, refer to X117H N Sheet for proper Setting.
  - In the case of non-successful settings, refer to X117H Calibration.
  
- Verify Analog inputs AI2= Upstream Pressure, AI3 = Downstream Pressure.
  - Verify Correct Reading and Scaling of Upstream Downstream Pressures, default Scaling of Cla-Val Pressure Transmitter is 0-290 psi.
  - Ensure Reading of Pressures is 0 psi at 4mA, if readings are different from a hydraulic gauge an offset setting may be necessary.
  
- Verify correct valve configuration is correct, units, Size, Body, Seat, Direction.
  - Ensure Valve Configuration is entered correctly.
- Verify Flow Units, Decimals, Low cutoffs.
  - Ensure Correct Flow units are used for proper flow reading.
  
- Verify if a DPM Inputs, P1 + P2 / Delta P.
  - Ensure correct configuration of XP2F Package.
  
- Verify Flow 4-20 Scaling of the Valve.
  - Ensure Correct Scaling of Flow 4-20 mA is correct for the proper Size Valve to Analog Output.
  
- Verify Logging configuration.
  - Ensure correct Date and Time for proper logging.
  - Ensure proper logging configuration and log entry.
  
- Exporting Logs.
  - Exported logs to SD-Card are as.csv.gz which requires 7-Zip to extract the file.
  - In the case of a corrupted SD-Card, an industrial SD-Card is preferred.
  - .csv files requires a From Text/CSV with a semicolon for a proper format.

Appendix A: Wiring schematic setup

A.1 2x X141-PTs and X117D

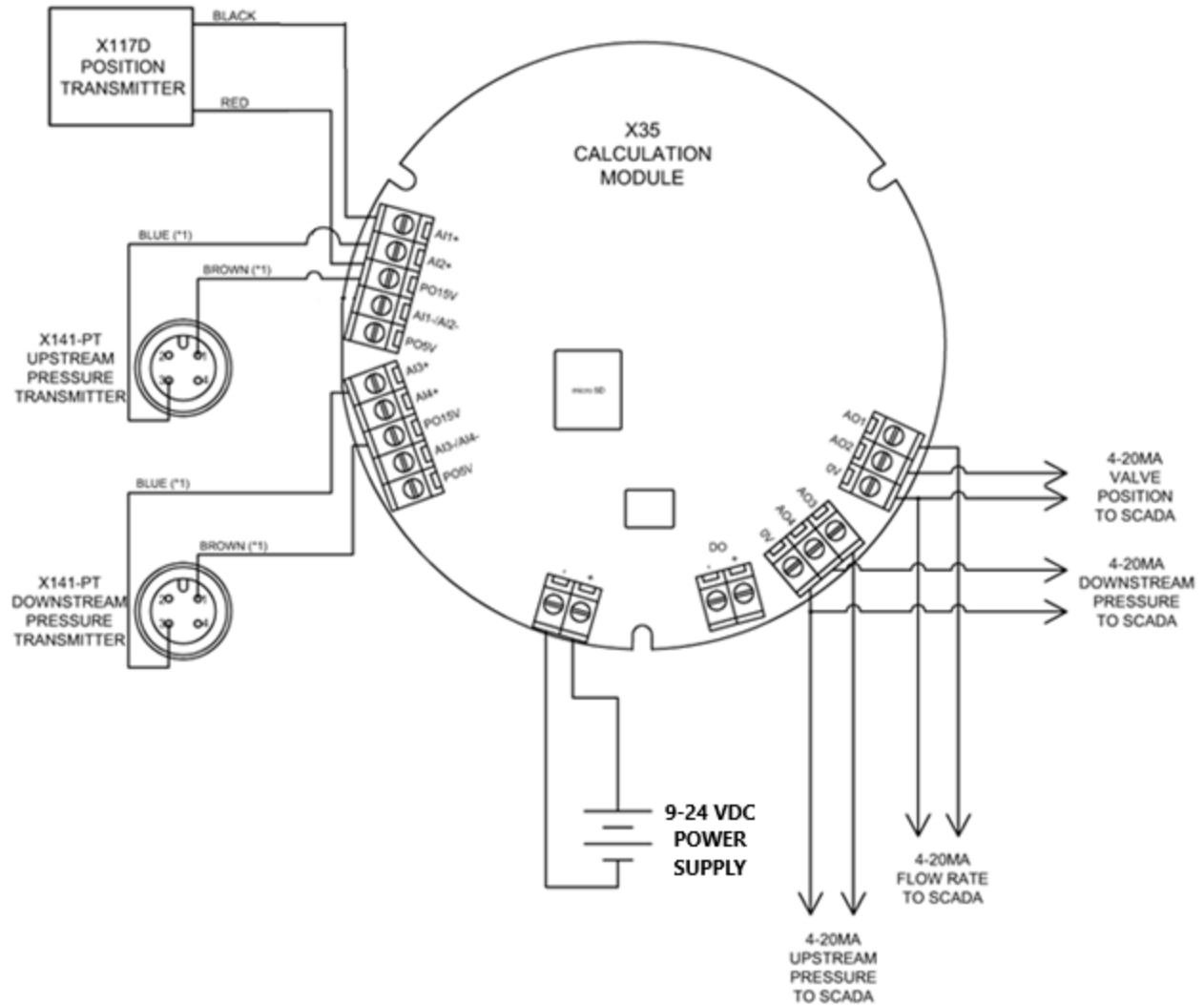

Figure A.1

A.2 DP Transmitter and X117D

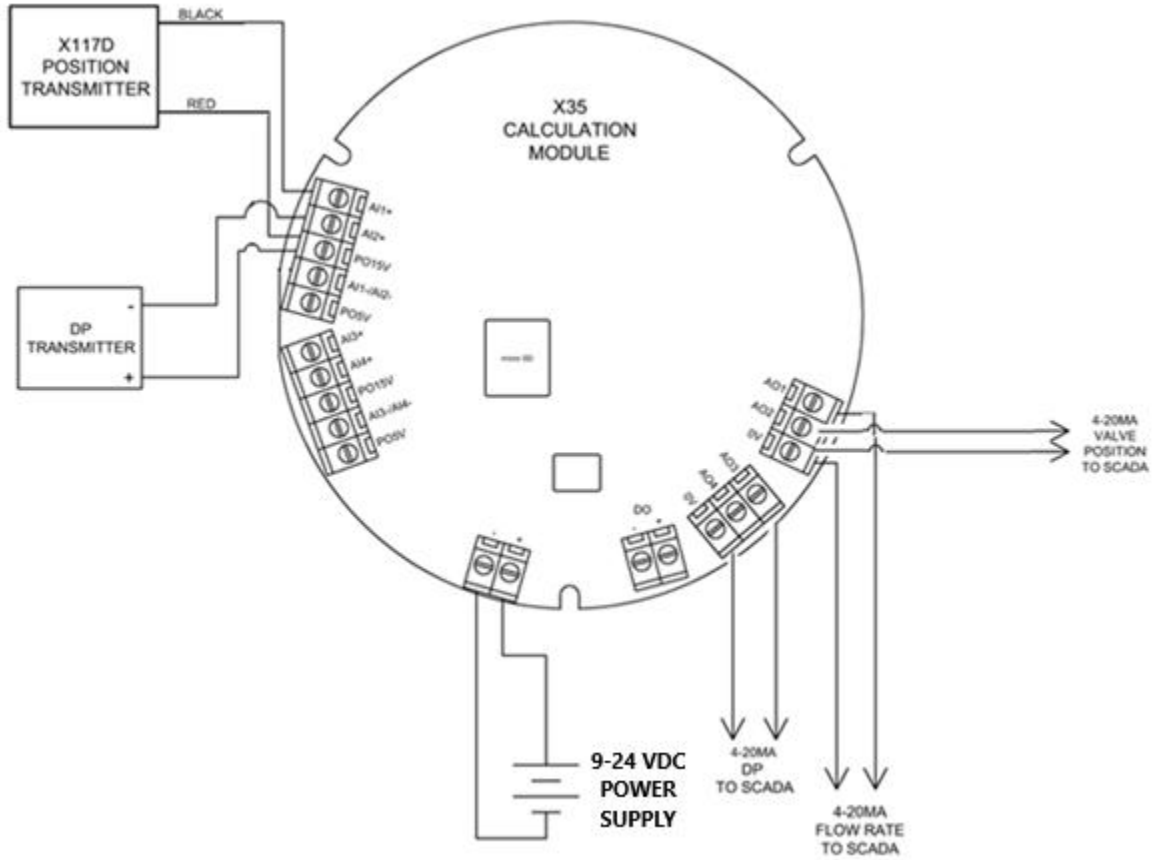

Figure A.2